

# AIRSIDE VEHICLE CONTROL HANDBOOK

Brisbane Airport Corporation

Version 2.5 | 4 September 2023



# Document Information

File Name	Airside Vehicle Control Handbook
Version	V2.5
Last Saved	4/09/2023 12:28:00 PM
Creator and Position	Jessie Jabore – Airside Services & Driving Coordinator
Acknowledgments	
Classification	
Approved By	Ryan Both – Executive General Manager Aviation
Approved Date	4/09/2023
In Force	Until Revoked

# Revision History

Version	Date	Creator	Position	Comments (Major Amendments)
V1.6	07.11.2019	David Selby	Airside Services Coordinator	<ul style="list-style-type: none"> <li>RETS Closure</li> <li>Taxiway Papa Rename (C12 &amp; C13)</li> </ul>
V1.7	27.02.2020	David Selby	Airside Services Coordinator	<ul style="list-style-type: none"> <li>Stop Bar Procedures</li> <li>Dryandra Road Underpass</li> <li>Penalty Table moved to Appendix A</li> </ul>
V2.0	Jun 2020	David Selby	Airside Services Coordinator	<ul style="list-style-type: none"> <li>New template</li> <li>Addition of SMC N</li> <li>New runway &amp; taxiway infrastructure</li> <li>Taxiway Lima turnaround loop</li> <li>Cat 3 &amp; 3RWY restricted area</li> <li>Taxiway (aircraft) directional flow</li> <li>Updated photos</li> <li>Addition of Airside Drivers map</li> <li>Northern Perimeter Road restrictions</li> </ul>
V2.1	24.08.2020	Jessie Jabore	ADA & AUA Service Officer	<ul style="list-style-type: none"> <li>Updated Forward</li> <li>ADA Holders Working for More than One Company</li> <li>ADA Licence Display Update</li> <li>Timber/Plastic Pallets Airside</li> <li>Updated Infringement Table</li> <li>Updated Maps</li> </ul>

V2.2	02.10.2020	Jessie Jabore	ADA & AUA Service Officer	<ul style="list-style-type: none"> <li>• Infringement 14.6 added</li> <li>• Airside Drivers Map Updated</li> </ul>
V2.3	22.01.2021	Jessie Jabore	ADA & AUA Coordinator	<ul style="list-style-type: none"> <li>• Updated ADA Identification sections 1.1 &amp; 1.1.2</li> </ul>
V2.4	23.08.2021	Jessie Jabore	ADA & AUA Coordinator	<ul style="list-style-type: none"> <li>• Updated Apron Definition</li> <li>• Northern Perimeter Rd Crossing reclassified as Taxilane Crossing</li> <li>• Red Hatching Areas – Spring Hydrant</li> <li>• TWY Papa, Fox 3, Northern Echo and Echo 3 reclassified as Designated Apron</li> <li>• Updated Figures</li> <li>• Added Tug Disconnect Point and Pushback Limit Marking Photos</li> </ul>
V2.5	04.09.2023	Jessie Jabore	Airside Services & Driving Coordinator	<ul style="list-style-type: none"> <li>• New ADA card designs</li> <li>• Cannot cross a live taxiway during declared Low Vis procedures</li> <li>• Infringement 16.7 added</li> <li>• Cannot traverse the perimeter road in reverse direction</li> <li>• Infringement 18.3 added</li> <li>• Papa and Decommissioned Runway (14/32) renamed</li> <li>• Delta 3 added as a live Apron Taxilane crossing</li> <li>• Added information on Staging / Clearance area</li> <li>• Figures 24, 25, 28, 35, 40, 42, 52, 57, 60, 66 and 68 updated</li> <li>• Revised information for GA Apron requirements</li> <li>• Runway edge light description</li> <li>• Logistics Turning Loop</li> <li>• Logistics Apron Widebody Aircraft</li> <li>• Airside Drivers Map</li> <li>• Taxiway aircraft directional flow maps</li> </ul>

# Contents

<b>FORWARD</b> .....	<b>7</b>
<b>INTRODUCTION</b> .....	<b>8</b>
<b>DEFINITIONS</b> .....	<b>9</b>
<b>1. Authority to Drive Airside (ADA)</b> .....	<b>13</b>
1.1 Authority to Drive Airside (ADA) - Application .....	13
1.1.1 Authority to Drive Airside – Identification .....	14
1.1.2 Authority to Drive Airside (ADA) – Testing .....	15
1.2 Authority to Drive Airside (ADA) – Categories .....	16
1.2.1 Category 1 ADA (Green) .....	16
1.2.2 Category 2 ADA (Orange) .....	16
1.2.3 Category 2A ADA (Blue) .....	17
1.2.4 Category 3 ADA (Red) .....	17
1.2.5 Category 3 – Runway ADA (Purple) .....	18
1.3 Authority for Use Airside (AUA) .....	18
1.3.1 Authority for Use Airside Application .....	18
1.3.2 Authority for Use Airside Insurance Requirements .....	19
1.3.3 Criteria for Use .....	19
1.3.4 Vehicle Requirements – Roadworthiness/Vehicle Condition .....	20
1.3.5 Dryandra Road Underpass .....	21
1.3.6 Authority for Use Airside – Identification .....	21
1.4 Aviation Security Identification Card (ASIC) .....	21
1.5 Basic Safety Rules and Procedures .....	21
1.5.1 Speed Limits .....	22
1.5.2 Baggage Make-up Areas (BMA) - Common User Facilities .....	22
1.5.3 Airside Speeding .....	23
1.6 Posted Height under Aerobridges .....	24
1.7 Seatbelts .....	25
1.8 Drug and Alcohol .....	25
1.9 Mobile Telephones .....	25
1.9.1 Personal Entertainment Audio Devices .....	25
1.10 Safety in the Vicinity of Aircraft .....	25
1.10.1 Situational Awareness .....	26
1.10.2 Fatigue .....	26
1.11 Clearances to Operating Aircraft .....	26
1.12 Red Anti-Collision Beacons and/or Strobes on Aircraft .....	28
1.13 Parking of Vehicles .....	28
1.14 Passenger Pathways .....	29
1.15 Emergency Eyewash Stations .....	29
1.16 Emergency Fuel Stop Button .....	29
1.17 Vehicle Lighting - General .....	30
1.18 Low Visibility Conditions - (Fog or heavy rain) .....	30
1.19 Thunderstorm Warning System .....	31
1.19.1 WHS Procedures .....	31
1.20 Foreign Object Debris (FOD) .....	31
1.20.1 Loads Secured and Covered .....	31
1.20.2 Rubbish Lids .....	32
1.20.3 Responsibility for FOD .....	32
1.20.4 Timber / Plastic Pallets Airside .....	32

1.21	Towing of cargo and equipment.....	32
1.22	Vehicle Escort/Supervision .....	32
1.23	Electronic Security Gates.....	33
1.24	No Smoking.....	33
1.25	Instructions by an Authorised Person .....	33
1.26	Perimeter Roads .....	34
1.27	Painted Stop Signs.....	34
1.28	Stop for Aircraft Markings.....	34
1.29	Taxiway & Apron Taxilane Crossings .....	35
1.29.1	Live Taxiway Crossing .....	35
1.29.2	Stop and Look at Taxiway / Apron Taxilane Crossings .....	36
1.30	Vehicle/Equipment Parking Areas.....	37
1.30.1	Vehicle/Equipment Clearance Area, known as Staging Areas .....	37
1.30.2	Vehicle/Equipment Storage Areas .....	37
1.31	Safety Areas .....	38
1.32	Vehicle/Equipment Fuel/Oil/Sewage Spills .....	38
1.32.1	Sewage Spills .....	38
1.33	Aerobridge Emergency Stop Buttons.....	39
1.34	Other Areas of Caution on the Perimeter Road .....	39
1.34.1	General Aviation.....	39
1.34.2	Perimeter Road - Runway 19R/01L .....	40
1.35	Airside Animals.....	41
1.36	Unpaved/Grassed Areas .....	41
1.37	Works Limit Markers (Red/Orange Witches Hats/ Bollards).....	42
1.38	Portable Movement Area Markers .....	42
1.39	Bicycles, Tricycles, Motorised Skateboards.....	43
1.40	Notifiable Incidents .....	43
1.41	Disciplinary Action .....	43
1.42	BAC Penalties .....	43
1.42.1	Appeal Process .....	44
<b>2.</b>	<b>Aircraft Stands – Restrictions on Areas of Travel .....</b>	<b>46</b>
2.1	Domestic Terminal Apron.....	46
2.2	International Terminal Apron.....	47
2.3	Logistics Apron.....	47
2.4	Airport South Parking Apron Requirements (Category 2 ADA or above) .....	48
2.5	Taxiway Foxtrot 3 (TWY F3) Northern Taxiway Echo (TWY E) and Taxiway Echo 3 (TWY E3) Requirements (Category 2 ADA or above) .....	48
2.6	General Aviation Apron .....	49
2.7	General Aviation Maintenance Area .....	49
2.8	Qantas Maintenance Hangars .....	50
2.9	Taxiway Mike (TWY M) Requirements (Category 2 ADA or above).....	51
2.10	Taxiway Hotel (TWY H) Requirements (Category 2 ADA or above) .....	53
2.11	Vehicles Cutting Across the Aprons.....	54
2.12	Apron Requirements .....	56
2.13	Vehicle Requirements .....	56
2.14	Advanced – Surface Movement Guidance Control System (A-SMGCS) .....	56
2.15	Radio Procedures.....	56
2.15.1	Radio Transceiver Failure .....	57
2.15.2	Radio Frequencies .....	57
2.15.3	Radio Read backs .....	58

2.15.4	Maintaining a Listening Watch on Movement Areas .....	59
2.16	Phraseology .....	59
2.17	Apron Lighting and Pavement Markings .....	60
2.18	Towing Aircraft .....	61
<b>3.</b>	<b>Taxiway Requirements .....</b>	<b>64</b>
3.1	Radio Frequencies .....	64
3.1.1	Radio Transceiver Failure .....	65
3.1.2	ATC Light Signals.....	66
3.2	Lighting and Pavement Markings.....	67
3.2.1	Runway Lighting and Pavement Markings.....	67
3.2.2	Taxiway Lighting and Pavement Markings .....	68
3.3	Runway Strip .....	68
3.4	Stop Bar Procedures .....	69
3.5	Movement Area Guidance Signs (MAGS) .....	69
3.6	Logistic Turning Loop .....	71
3.7	Logistics Apron – Widebody Aircraft (wingspan >36m) .....	72
3.8	Some General Tips .....	72
3.9	Radio Frequencies .....	74
3.9.1	Procedure .....	74
3.10	Runway Crossings Requirements.....	75
3.10.1	Stop Bar Procedures .....	76
3.11	Scenarios .....	79
3.11.1	Scenario 1: Virgin Hangar to Domestic Apron .....	79
3.11.2	Scenario 2: Domestic Apron to Qantas Hangar 2 .....	80
3.11.3	Scenario 3: General Aviation Apron to Toll Hangar .....	81

## Appendices

Appendix A	BAC Penalties Table
Appendix B	Airside Drivers Map
Appendix C	Taxiway Aircraft Directional Flow Maps

# FORWARD

This Airside Vehicle Control Handbook has been developed in the interests of greater safety on the airside of Brisbane Airport.

This Handbook details safety rules for drivers of vehicles on the airside at Brisbane Airport. The purpose of these rules is to provide a safe and secure environment in which to undertake aerodrome operations. The overriding requirements are that all airside vehicles must have certain equipment and characteristics, and that the drivers of them must:

- Drive in a safe manner;
- Ensure that driving and parking do not impede flight operations or aircraft movements; and
- Be aware of the aviation environment and its inherent dangers.

Brisbane Airport Corporation (BAC) has a general duty of care at common law and obligations under the Civil Aviation Act 1988 and the Aviation Transport Security Act 2001 in relation to safety and security issues associated with surface vehicles operating in such areas (**Regulatory Obligations**).

In addition BAC has powers under the Airports (Control of On-Airport Activities) Regulation 1997 and Work Health and Safety legislation, to issue directions on matters concerning safety and security at Brisbane Airport, including the control of vehicles on the airside.

The Airside Vehicle Control Handbook is just one of many measures making up the complete Safety Management System (SMS). Any breach of the general safety rules, or any safety related incident is reported and examined to find the root cause of the issue and to try to eliminate, mitigate or control this cause moving forward.

Failure to comply with the requirements of this Handbook is a breach of Regulatory Obligations and possibly may impact the right of an operator to use or access the airside for the purpose of their work. All failures are reviewed by BAC when considering whether to exclude individuals or entities from airside the use of motor vehicles airside.

BAC is always actively considering ways to improve airside safety and encourage responsible driving behaviours.

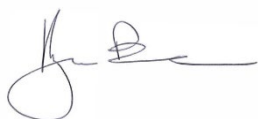

**Ryan Both**

Executive General Manager of Aviation  
Brisbane Airport Corporation

# INTRODUCTION

This Airside Vehicle Control Handbook has been produced in the interests of safety and driver education at Brisbane Airport. It details basic safety rules and driving standards required for drivers of vehicles on the Airside of Brisbane Airport.

These rules and standards are an important part of the system that Brisbane Airport Corporation (BAC) has put in place to promote the safe and orderly movement of passengers, aircraft and vehicular traffic airside.

The requirements of this Handbook are deemed to be included in the conditions on which BAC issues:

- a. an Authority to Drive Airside (ADA); and
- b. an Authority for Use Airside (AUA), for Brisbane Airport.

Failure to comply with the requirements of this Handbook is a breach of the conditions of issue of an ADA or AUA (as the case may be) and will be taken into account by BAC in considering whether to fine (under the Airports Act Control of On-Airport Activities) suspend or cancel an individual Driver's ADA, or the AUA for a vehicle.



# DEFINITIONS

ITEM	DEFINITION
<b>Aerodrome or Airport</b>	A defined area of land or water (including any buildings, installations and equipment), intended to be used either wholly or in part for the arrival, departure and movement of aircraft.
<b>Airport</b>	Means Brisbane Airport.
<b>Airside</b>	The area of Brisbane Airport, adjacent terrain, roads and buildings or portions thereof, access to which is controlled, bounded by the perimeter fence, as shown on the attached "Airside" map.
<b>Approved Issuing Authority</b>	BAC is the only authority to issue Category 1, 2, 2A, 3 and 3-RWY ADA.
<b>Airside Operations Centre (AOC)</b>	BAC's Airport Operations Centre which is located at Gate 12A, Baeckea Street, Brisbane Airport
<b>Aircraft Stand</b>	That part of Brisbane Airport to be used for: <ul style="list-style-type: none"> <li>• The purpose of enabling passengers to board, or disembark from aircraft;</li> <li>• Loading cargo onto, or unloading cargo from aircraft;</li> <li>• Refuelling, parking or carrying out maintenance on aircraft.</li> </ul>
<b>Apron</b>	Aircraft Stand plus Apron Taxilane equals Apron; the portion of the aircraft parking area used for access between taxiways and aircraft parking positions. Taxiways H2N, H2S and M are classified as Apron for access to and from the hangars. Taxiways F3 and E3 are classified as designated apron for the parking of aircraft. Northern Taxiway E has also been classified as apron for access to parking.
<b>Apron Taxilane</b>	That part of Brisbane Airport to be used for aircraft manoeuvring behind Aircraft Stands requires a Category 2A ADA.
<b>Air Traffic Control (ATC)</b>	ATC is Aerodrome and Surface Movement Control.
<b>Aerodrome Terminal Information Service (ATIS)</b>	ATIS broadcasts contain essential information, such as weather information and which runways are active.
<b>Authorised Person</b>	Means a person authorised under an appropriate statutory instrument for the purposes of the <i>Airports (Control of On-Airport Activities) Regulations</i> and includes BAC and Australian Federal Police (AFP).
<b>Authority to Drive Airside (ADA)</b>	An authority issued by BAC to a driver for the purpose of driving in certain areas on the Airside.
<b>Authority for Use Airside (AUA)</b>	An authority issued by BAC authorising a vehicle to be used on the airside.
<b>Aviation Security Identification Card (ASIC)</b>	Is a card that identifies that the holder has undergone the necessary background checks and is entitled to enter and be in a Security Restricted Area of the airport while undertaking duties in accordance with their employment. The card may also be used to provide access to those areas.
<b>BAC</b>	Means Brisbane Airport Corporation Pty Ltd, the airport operator for Brisbane Airport.
<b>Driver</b>	Is any person operating a vehicle on the airside of Brisbane Airport.
<b>DTB</b>	Domestic Terminal Building.
<b>Escort</b>	Means the supervision of a vehicle airside whereby the supervising person takes responsibility for and will provide guidance and may take immediate action to prevent an unsafe act by the vehicle being escorted.

ITEM	DEFINITION
<b>Equipment Clearance</b>	Vehicle/Equipment staging areas are defined by a single broken red line, being areas where vehicles and equipment may be parked while waiting to service aircraft. These areas must not be used to store vehicles and equipment not being directly used to service aircraft.
<b>Equipment Storage</b>	Vehicle/Equipment storage areas are defined by a single solid red line, being areas where vehicles and equipment may be parked. These areas must only be used for the storage of equipment that is not readily moved to the GSE areas for storage.
<b>Foreign Object Debris (FOD):</b>	Includes any object found in an inappropriate location that, as a result of being in that location, can damage aircraft, equipment or injure personnel. FOD includes a wide range of material, including loose hardware, pavement fragments, catering supplies, building materials, rocks, sand, pieces of luggage, and even wildlife.
<b>GA</b>	General Aviation Apron.
<b>Handbook</b>	This handbook including its attachments.
<b>ITB</b>	International Terminal Building.
<b>Jetblast</b>	The force or wind generated behind a jet engine, particularly on or before take-off when high/full power is set, but also when the aircraft is taxiing.
<b>Landside</b>	That portion of Brisbane Airport not designated as airside and to which the general public normally has free access.
<b>Leased Area</b>	Means a portion of land whose geographic limits are defined in this Handbook (for the purposes of excluding the leased area from the provisions of the Handbook) and on the ground (by green line), and where the lessee is responsible for the control of all vehicles within the boundaries of that leased area. All drivers must have the appropriate State or Territory Licence.
<b>Manoeuvring Area</b>	Those parts of Brisbane Airport used for the take-off, landing and taxiing of aircraft, excluding Aprons.
<b>Markings</b>	Symbols, lines, words and figures displayed on the surface of a Movement Area, or special visual distinguishing features added to vehicles.
<b>Movement Area</b>	That part of Brisbane Airport that is used for the surface movement of aircraft including Manoeuvring Areas and Aprons. Manoeuvring Area plus apron equals Movement Area.
<b>Notifiable Incident</b>	Any vehicle/plant incident which: <ul style="list-style-type: none"> <li>• Causes personal injury; and/or</li> <li>• Causes property damage; and/or</li> <li>• Which may involve BAC in litigation.</li> </ul>
<b>NOTAM (Notice To Airmen)</b>	NOTAMs are created and transmitted by government agencies and airport operators. NOTAMs are issued (and reported) for a number of reasons, such as but not limited to: Hazards (e.g. wildlife), closed runways or taxiways, inoperable radio navigational aids, temporary erection of obstacles near airfields (e.g. cranes) .
<b>Perimeter Road</b>	A road within the Airside to facilitate travel of vehicles to various areas whilst remaining clear of the Movement Areas (except in specific areas where a clearly marked perimeter road may cross a Taxiway).
<b>Propwash</b>	The force or wind generated behind a propeller, particularly on or before take-off when high/full power is set, but also when the aircraft is taxiing.

ITEM	DEFINITION
<b>Restricted Area</b>	Means any part of the airport, designated by notices posted by BAC, access to which is restricted to (a) persons holding an authorised identification card valid for that part of the airport, (b) having a lawful excuse for entry and (c) persons holding a valid (unrestricted) ADA to drive within that part of the airport.
<b>Runway (RWY)</b>	A defined rectangular area on a land aerodrome, prepared for the take-off and landing of aircraft along its length.
<b>Runway Strip (RWS)</b>	A defined area including the runway and stopway (if provided), intended to reduce the risk of damage to aircraft running off a runway and to protect aircraft flying over it during take-off or landing operations.
<b>Security Controlled Airport</b>	An Airport which has been declared by the Department of Infrastructure and Regional Development as a “security controlled airport” pursuant to section 28(2) of the Aviation Transport Security Act 2004.
<b>Security Restricted Area</b>	Means any part of the Airport, designated by notices posted by BAC, access to which is restricted to (a) persons holding an authorised identification card valid for that part of the airport and (b) having a lawful excuse for entry.
<b>Shared Zone</b>	The area is shared by pedestrians and vehicles.
<b>SMC</b>	Surface Movement Control.
<b>SMC S</b>	Surface Movement Control – South.
<b>SMC D</b>	Surface Movement Control – Domestic.
<b>SMC N</b>	Surface Movement Control – North.
<b>Speed Limit</b>	The speed limit in a particular area as specified in this Handbook.
<b>Stop Bar</b>	Runway Stop Bars are a series of inset & elevated red lights which are located at all runway holding points. Drivers must not cross the Stop Bars while they are illuminated and without ATC clearance.
<b>Subsidiary</b>	A wholly owned subsidiary.
<b>Taxiway (TWY):</b>	A defined path on a land aerodrome established for the taxiing of aircraft and intended to provide a link between one part of the aerodrome and another, including field Taxiway, Aircraft Stand Taxiway, Apron Taxiway and rapid exit Taxiway.
<b>TWR</b>	Tower (Air Traffic Control).
<b>Vehicle</b>	Any self-propelled ground surface vehicle or mobile equipment (including specialised aircraft servicing vehicles and ramp equipment). This includes elevated work platforms.
<b>Vehicle Operator</b>	The organisation, owner or driver, (including government departments, agencies or business enterprises) controlling the operation of one or more vehicles on airside, or any person who has rented such a vehicle for operation by their own agents.

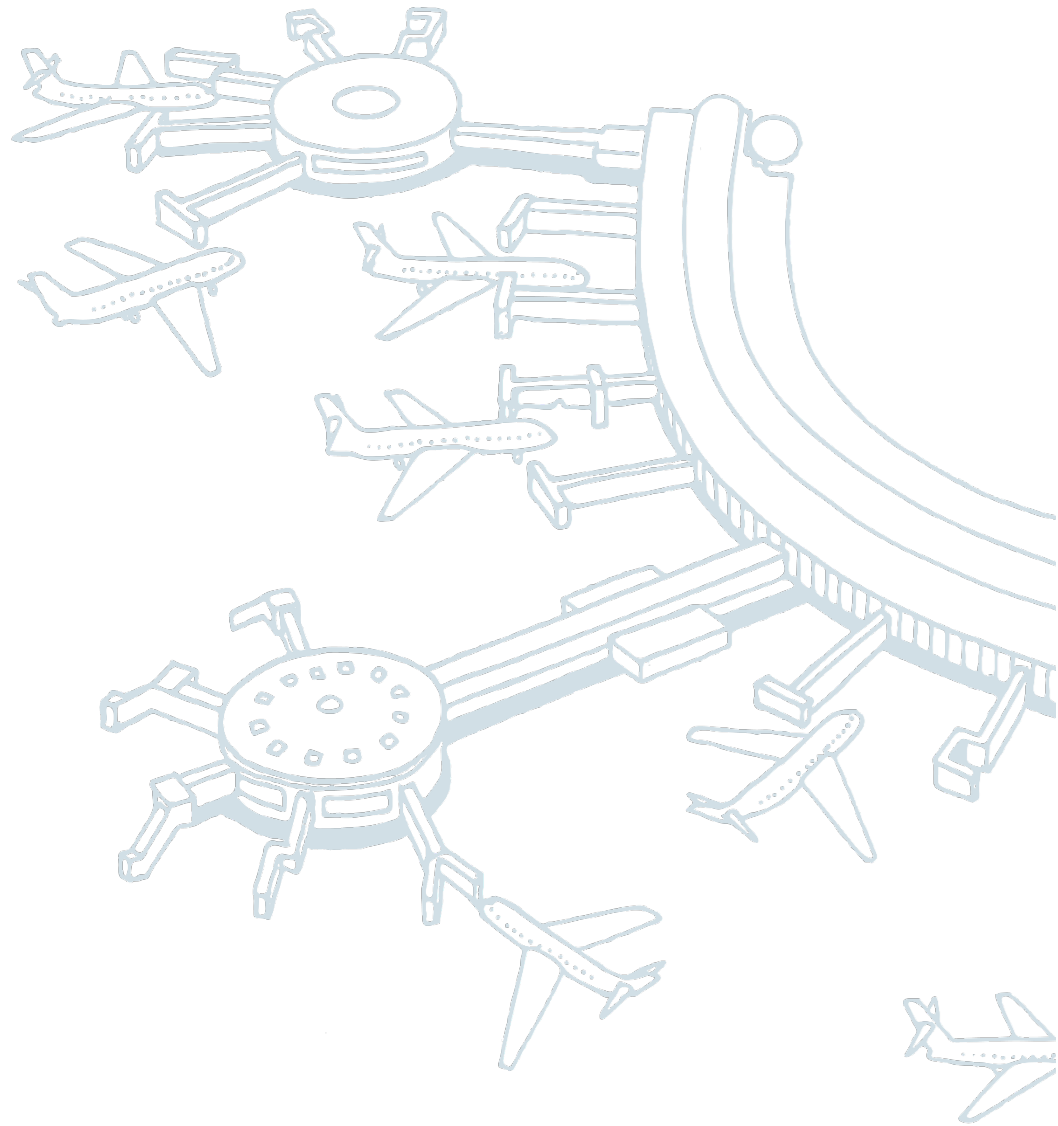

# CATEGORY 1 AUTHORITY TO DRIVE AIRSIDE

**Perimeter Roads Only** (Excluding Restricted Area accessed only by ARFF,BAC,AFP,ABF,ASA & approved contractors – refer Appendix B)

Applicants for Category 1 are only required to read this section

# 1. AUTHORITY TO DRIVE AIRSIDE (ADA)

Drivers operating Airside must hold an Authority to Drive Airside (ADA) licence for Brisbane Airport. An Authority to Drive Airside licence is not transferable between individuals or between airports. All ADA licences are valid for a two-year period, unless withdrawn or suspended. The minimum suspension period is one (1) month.

## 1.1 Authority to Drive Airside (ADA) - Application

Before applying for an Authority to Drive Airside, a Driver must satisfy the following requirements:

1. Has an operational need to drive unescorted on the airside;
2. Holds a full current State, Territory or International (not necessarily the State or Territory in which an application is requested) drivers licence for the type of vehicle intended to be driven and, where appropriate, is endorsed with a vehicle operator certificate of competency or licence to cover the specific type or types of vehicles or equipment to be operated and is able to operate the vehicle or equipment concerned in a competent and safe manner. Learner Driver Licences are not permitted to drive airside. Provisional drivers do not require to display their P plates airside, but are required to adhere to any limitations under their Provisional licence;
3. International Driver's Licence - an endorsement letter must be submitted from the employer noting that they are aware that the driver has an international licence and appropriate training has been received.
4. As the airport is a Security Controlled Airport, holds an Aviation Security Identification Card (ASIC) for the Airport;
5. Has completed prior to testing, sufficient training to be fully conversant with the contents of this Handbook;
6. If required to operate on the Manoeuvring Area, holds an "Aeronautical Radio Operator Certificate" issued by CASA and is able to comprehend visual signals that may be issued by ATC;
7. Understands the significance and meaning of Apron signs and Markings;
8. Is proficient in the terminology used to describe the airside and is familiar with the airport layout relevant to their driving duties;
9. Has completed the following **minimum** requirements, within three months of the individuals ADA test, relevant to the category of ADA licence being applied for as a trainee in a vehicle on the airside;
  - 4 (four) hours in relation to a new application for an Authority to Drive Airside licence Category 1
  - 8 (eight) hours in relation to a new application for an Authority to Drive Airside licence Category 2, 2A, 3 and 3RWY
10. ADA licence upgrades are available for applicants who may require due to operational requirements, an upgraded ADA licence. Brisbane Airport Corporation has set the following guidelines for all ADA upgrades:
  - a. For an ADA licence upgrade from a CAT 1 to a CAT 2
    - i. Log sheet minimum of 4 (four) hours in all conditions relevant to CAT2
  - b. For an ADA licence upgrade from a CAT 2 to CAT 2A
    - i. Radio Operator Certificate
    - ii. Log sheet minimum of 4 (four) hours in all conditions relevant to CAT 2A (including a minimum of 4 (four) push backs)
  - c. For an ADA licence upgrade from a CAT 2 or CAT 2A to a CAT 3 or CAT 3 RWY
    - i. Radio Operator Certificate

- ii. Log sheet minimum of 4 (four) hours in all conditions relevant to CAT 3 or CAT 3RWY (including a minimum of 2 (two) hours of night driving manoeuvring taxiways)
  - iii. CAT 3RWY – including a minimum of 2 (two) night RWY (19L/01R) crossings.
11. It is the responsibility of the employee and the employer to renew the employee's ADA prior to the expiry date listed on the ADA or no longer than 30 (thirty) days from this date. All applicants have a 30 (thirty) days grace period from the date of expiry to come and sit the test, before having to recomplete the 4 (four) or 8 (eight) hour logbook component (depending on category). All applicants will need to recomplete the test to renew their licence. An individual must renew their ADA before expiry or within 30 (thirty) days of the expiry date to avoid having to recomplete logbook hours.
12. It is the responsibility of the employee to transfer the ADA licence at the BAC ADA & AUA Office (on level 2 of the DTB) to an alternative company within 30 (thirty) days of ceasing employment with the company listed on the ADA licence. Should this not be completed within this timeframe, the ADA is invalid, the applicant can no longer use this ADA and they must recomplete logbook hours and sit the test again with the new company.
13. It is the responsibility of the employee to return the ADA licence upon expiry or cease of employment to the BAC ADA & AUA Office (on level 2 of the DTB) within 30 (thirty) days.
14. When an ADA holder works for more than one company, it is the responsibility of the employee to notify the ADA & AUA Office and fill in the required letter. An ADA reprint is then required to notate the secondary company on the back of the ADA. Only once this has been finalised is the employee able to commence driving for the secondary company. Please email [airsidelicence@bne.com.au](mailto:airsidelicence@bne.com.au) for more information should you require this.
15. It is the responsibility of the employee to return a suspended ADA licence to the BAC ADA & AUA Office (on level 2 of the DTB) within 14 (fourteen) days.
16. ADA licences expired or suspended for a period of 4 (four) weeks or more will have to recomplete the 4 (four) or 8 (eight) hour logbook training relevant to the category of ADA licence held; and
17. An applicant's employer must certify the trainee has satisfied the BAC Airside Driver's Logbook criteria for the category of ADA licence being applied for and is deemed competent to drive airside prior to testing.

The most up to date Airside Vehicle Control Handbook and ADA documentation is located on the [Airside Driving Centre](#) webpage, on the Brisbane Airport website.

### 1.1.1 Authority to Drive Airside – Identification

Whenever a driver is driving airside or is in charge of another vehicle/s airside, all driver/s must comply with a direction from an Authorised Person to produce their ADA and/or state/territory/international drivers licence.

A driver may be asked to provide a drivers licence upon request from an Authorised Person; the driver must comply with the authorised persons request to present the State, Territory or International Licence within a 24 hour time period at the required location.

An ADA can only be issued to a Driver with the appropriate Licence who holds a State, Territory or International Drivers Licence, and a certificate of competency to cover the specific types of vehicles or equipment to be operated and is able to operate the vehicle or equipment concerned in a competent and safe manner.

Where a driver who holds an ADA loses their State, Territory or International Drivers Licence and is unable to obtain a special licence through the courts to either drive to and from work or to drive as part of their employment, the holder of the ADA must immediately notify the vehicle operator and surrender their ADA to BAC until the State, Territory or International Licence has been reinstated to the individual.

All documentation for Airside Driving can be downloaded from the [Airside Driving Centre](#) on the Brisbane Airport website.

## 1.1.2 Authority to Drive Airside (ADA) – Testing

### 1.1.2.1 Purpose of Testing

The purpose of conducting ADA tests is to provide evidence that the applicant has attained a level of competency in terms of knowledge and skills applicable to driving safely on the airside.

Material tested includes the geography of the airport and the rules for driving airside. Questions are drawn from information provided in the Airside Vehicle Control Handbook relevant to the category of ADA.

### 1.1.2.2 Driver Competency

Each employer will be responsible for training their driver/s in the safe and correct operation of any vehicle or equipment the driver is to operate airside.

### 1.1.2.3 Testing Process

All current ADA holders who are undertaking an ADA assessment must surrender their current ADA until such a time they can successfully pass the test. Failing an ADA renewal does not demonstrate the required competency for driving airside.

Your employer will be sent an invoice for this application fee.

Applicants for all Categories of ADA are required to pass any reasonable and relevant tests, which comprise of an online theory assessment completed within the designated timeframes:

ADA Category	Questions	Pass mark	Timeframe	\$ ex GST
Category 1	20	18/20	30 minutes	
Category 2	40	37/40	40 minutes	
Category 2A	40	37/40	40 minutes	
Category 3	60 (inclusive of 10 geographic questions – no more than 3 incorrect on taxiway map)	55/60	60 minutes	
Category 3RWY (Excluding Restricted area)	75 (inclusive of 10 geographic questions – no more than 3 incorrect on taxiway map)	70/75	60 minutes	As per ADA Application Form / Passport System
<i>Restricted area – (BAC &amp; ARFF only)</i>	<i>85 (inclusive of 15 geographic questions – no more than 3 incorrect on taxiway map)</i>	<i>80/85</i>	<i>60 minutes</i>	
Reprint of an ADA				
Change of Employer / Details on ADA Card				

### 1.1.2.4 Unsuccessful Applicants

Should an applicant be unsuccessful in correctly answering these questions, they must re-sit the entire test, but may only do so after a mandatory study/training period of no less than 72 (seventy-two) hours.

### 1.1.2.5 Payment Terms

The Airside Driving Office does not have payment facilities. Organisations will be invoiced; options for payment methods are included on the BAC invoice.

**Payment must be made within 30 days or the ADA will be cancelled. BAC may not issue further ADA's and AUA's until such time as the outstanding money has been paid.**

# 1.2 Authority to Drive Airside (ADA) – Categories

There are five categories of Authority to Drive Airside at Brisbane Airport, and each category represents a distinct area on the Airport drivers are authorised to operate within. Please note we currently have two ADA designs active. The following examples on the left are the old ADA designs and the examples on the right are the new ADA designs. The old ADA is currently being phased out and will no longer exist past the end of March 2025.

## 1.2.1 Category 1 ADA (Green)

An Authority issued by BAC following a satisfactory written test, to a driver for the purpose of driving on **Perimeter Roads only; (Excluding Restricted area accessible only by authorised vehicles ARFF & BAC – refer Airside Drivers Map Appendix B);**

- The Perimeter road includes crossing specific Taxiways Lima, Mike, Hotel 3, Hotel 4 & Echo as well as a Taxilane at the Northern ITB apron. Where the Perimeter Road crossing the Taxiway/Taxilane is marked, and when the driver has received training to be able to do so.
- This Authority will be valid for a maximum of two years.
- In the case of emergency within the Dryandra Road underpass, observe and obey traffic control measures.

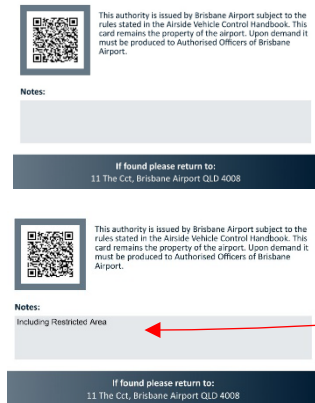
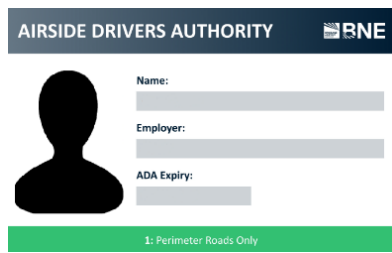
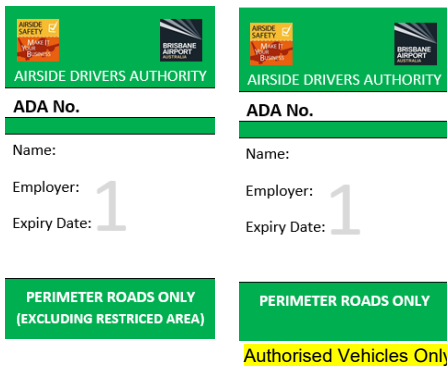

## 1.2.2 Category 2 ADA (Orange)

An Authority issued by BAC following a satisfactory written test, to a driver for the purpose of driving on the **Perimeter Roads and Aircraft Stands; (Excluding Restricted area accessible only by authorised vehicles ARFF & BAC – refer Airside Drivers Map Appendix B);**

- The Perimeter road includes crossing specific Taxiways Lima, Mike, Hotel 3, Hotel 4 & Echo as well as a Taxilane at the Northern ITB apron. Where the Perimeter Road crossing the Taxiway/Taxilane is marked, and when the driver has received training to be able to do so.
- This Authority will be valid for a maximum of 2 (two) years.
- In the case of emergency within the Dryandra Road underpass, observe and obey traffic control measures.

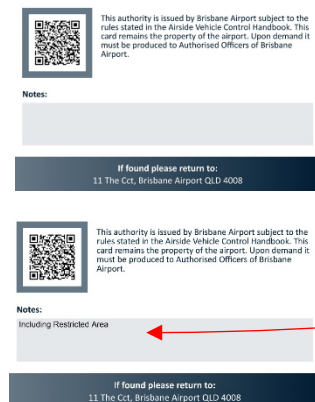
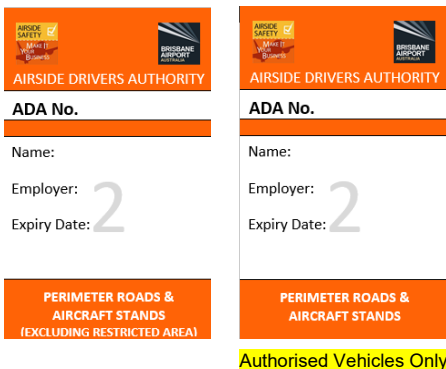



### 1.2.3 Category 2A ADA (Blue)

An Authority issued by BAC following a satisfactory written test, to a driver for the purpose of driving on the **Perimeter Roads up to and including the Aprons** – which permits pushbacks and relocating of aircraft on the Apron; **(Excluding Restricted area accessible only by authorised vehicles ARFF & BAC – refer Airside Drivers Map Appendix B):**

- The Perimeter road includes crossing specific Taxiways Lima, Mike, Hotel 3, Hotel 4 & Echo as well as a Taxilane at the Northern ITB apron. Where the Perimeter Road crossing the Taxiway/Taxilane is marked, and when the driver has received training to be able to do so.
- This Authority will be valid for a maximum of two years.
- To qualify for this Authority, a driver must hold an “Aeronautical Radio Operator Certificate” issued by Civil Aviation Safety Authority (CASA).
- In the case of emergency within the Dryandra Road underpass, observe and obey traffic control measures.

### 1.2.4 Category 3 ADA (Red)

An Authority issued by BAC following a satisfactory written test by BAC, to a driver for the purpose of driving on the **Perimeter Roads up to and including the Taxiways** **(Excluding Restricted area accessible only by authorised vehicles ARFF & BAC – refer Airside Drivers Map Appendix B):**

- This Authority will be valid for a maximum of two years.
- To qualify for this Authority, a driver must hold an “Aeronautical Radio Operator Certificate” issued by Civil Aviation Safety Authority (CASA).

## 1.2.5 Category 3 – Runway ADA (Purple)

An Authority issued by BAC following a satisfactory written test by BAC, to a driver for the purpose of driving on the **Perimeter Road up to and including All Movement Areas (Excluding Restricted area accessible only by authorised vehicles ARFF & BAC – refer Airside Drivers Map Appendix B)**;

- This Authority will be valid for a maximum of two years. This is the only category of ADA authorised to cross and/or enter a Runway with permission from the Tower.
- To qualify for this Authority, a driver must hold an “Aeronautical Radio Operator Certificate” issued by Civil Aviation Safety Authority (CASA).

The image shows two examples of Airside Drivers Authority (ADA) cards. The top card is for '3RWY: All Movement Areas' and the bottom card is for 'ALL MOVEMENT AREAS (EXCLUDING RESTRICTED AREA)'. Both cards include fields for ADA No., Name, Employer, and Expiry Date. The bottom card is highlighted with a yellow box labeled 'Authorised Vehicles Only'.

## 1.3 Authority for Use Airside (AUA)

Vehicles operating airside at Brisbane Airport must have an Authority for Use Airside (AUA) for Brisbane Airport which is to be on display at all times.

### 1.3.1 Authority for Use Airside Application

The BAC AUA Application Form must be accompanied by the following documents:

1. Letter from a responsible manager of the vehicle owner confirming that a maintenance program is in place to ensure the vehicle remains in a sound mechanical and roadworthy condition; and
2. A signed BAC Indemnity; and
3. Evidence of both Public Liability insurance (listing BAC as an interested party) and Motor Vehicle Insurance.

In applying for an AUA, vehicle operators must acknowledge and accept that the holding of an AUA for a vehicle is not an automatic right to enter the airside.

Every application for an AUA is reviewed on a case-by-case basis. The holding of a current AUA is not sufficient grounds for an automatic renewal of the AUA for that vehicle, or for any other vehicle of an organisation.

Applications must be submitted to BAC *no less than 10 (ten) working days before* the vehicle operator wishes to use the vehicle on the airside.

If granted, an AUA permit will be issued for a period of *no more than 12 (twelve) months*. An AUA permit will expire 1 (one) month after the vehicle operator’s Public Liability policy expires.

It is the vehicle operator’s responsibility to ensure that they are covered by insurance whilst holding an AUA permit and that their insurance documents are renewed prior to an AUA renewal.

## 1.3.2 Authority for Use Airside Insurance Requirements

### 1.3.2.1 At all times, the Driver / Vehicle Operator must:

1. Take out and keep current a CTP and Motor Vehicle Insurance for the vehicle(s) the subject of the AUA permit, noting use of vehicle airside; and
2. Take out and keep current a Public Liability Insurance, against any liabilities for death, personal injury and property damage that may be incurred in connection with the operation or use of vehicle on the Airside, ensuring that such insurance:
  - a. Is taken out with a reputable insurer;
  - b. Notes the interest of BAC;
  - c. Covers risks and contains conditions which are acceptable to BAC, acting reasonably;
  - d. Is for an amount no less than:
    - i. AUD \$20 million for vehicles accessing Perimeter Roads, Aircraft stands, Aprons and Manoeuvring areas when towing aircraft only; or
    - ii. AUD \$50 million for vehicles accessing Runways, Taxiways and Aircraft Manoeuvring Areas to conduct airside construction works/repairs, and
  - e. Does not contain any exclusionary clauses relating to any airport infrastructure, aircraft or matters relating to or in connection with the operation of vehicles on the Airside, and contains an 'airside endorsement';
3. Not do, or permit to be done, anything which might prejudice such insurance policy and must immediately rectify anything which might prejudice such insurance policy.

### 1.3.2.2 The Driver / Vehicle Operator must notify BAC if:

1. the policy is cancelled, or not renewed, or the Driver / Vehicle Operator cannot or has not paid the premium for the insurance;
2. something happens that gives rise, or might give rise, to a claim under the policy; or
3. a claim is refused.

### 1.3.2.3 The Driver / Vehicle Operator must:

provide BAC with a summary of insurance policy (including what is insured under the policy) and any certificates of insurance connected with it, as soon as it is taken out, renewed (whether annually or more frequent) or at the request of BAC;

### 1.3.2.4 The Driver / Vehicle Operator must;

not operate or have a vehicle on the Airside, if the above insurances are not current or in place.

The insurance in this paragraph 1.3.2 may form part of the Driver / Vehicle Operators insurance for the use of Brisbane Airport as a whole. The Driver / Vehicle Operator's insurance will satisfy these insurance requirement if it, or its employer, maintains a global insurance public liability insurance policy that covers use of vehicles on the airside and otherwise complies with the requirements set out in this paragraph 1.3.2.

Nothing in this paragraph 1.3.2 limits the obligations, liabilities and responsibilities of the Driver / Vehicle Operator.

## 1.3.3 Criteria for Use

The major criteria for the issue or renewal of an AUA is that the applicant must demonstrate an operational need to drive a vehicle on the airside on a frequent and unescorted basis. The applicant must further show that the operational task(s) cannot be otherwise undertaken landside.

The applicant must, to the satisfaction of BAC, meet one or more of the following:

1. Be directly involved with the operations or servicing of aircraft;
2. Be directly involved with the servicing of Ground Service Equipment (GSE);
3. Be directly involved with the servicing, maintenance or construction of airside infrastructure, aviation equipment, building/s, or other airside facilities, and that these areas cannot be reached via the landside;
4. Have a need or authority to carry out government regulatory or law enforcement activities on the airside.

In deciding whether to issue an AUA, BAC will consider the following:

- Safety on the airside in relation to aviation operations, persons on the airside and property on the airside;
- Congestion of airside areas, thereby decreasing the efficiency of the airport (particularly ramp areas), and increasing the risk of accident to all users of Brisbane Airport;
- The ability of the vehicle operator to ensure that the operation of the vehicle will comply with the requirements of this Handbook and with all laws, rules, standards and directions including, where applicable, legislative requirements and Air Traffic Control directions, relating to the operation of vehicles in the area;
- The vehicle will be maintained in a state of good repair. The driver is to ensure vehicle's being operated airside must be mechanically and/or electrically sound.

### 1.3.4 Vehicle Requirements – Roadworthiness/Vehicle Condition

Vehicles must:

- Be fitted with an amber rotating beacon if intended for use on the Aircraft Stands and beyond;
- Be registered for use on public roads, and meet the mechanical and roadworthiness requirement under the law of the State of Queensland; **or**
- In the case of a specialist airport vehicle, the vehicle must meet industry standards, if any, for such a vehicle and/or the IATA specifications, if any, for such a vehicle and be mechanically sound;
- Vehicles above 3.8 metres have the vehicle height clearly displayed on the interior of the cabin and on an external surface of the vehicle;
- BAC reserves the right at any time, to conduct or require the conduct of a serviceability inspection on any vehicles which in the opinion of BAC, appear not to be in a roadworthy condition.

A vehicle serviceability check may include (but is not limited to) the following:

- Fluid leaks
- Excess emissions
- Towing attachments
- Seat belts (if fitted)
- Tyre condition
- All vehicle lights
- Body condition
- Horn (if fitted)

**PENALTY: Vehicle operators not complying with this requirement shall have the vehicle's AUA immediately cancelled and the vehicle removed from airside. The AUA may be reissued once repairs have been affected and BAC has received written verification from an appropriately qualified person to that effect.**

### 1.3.5 Dryandra Road Underpass

The Dryandra Road underpass forms a section of the Airside Perimeter Road and has a posted height restriction of 4.6 metres. In the event of closure of the underpass, abide by traffic control management.

Figure 1 Dryandra Road Underpass Height Restriction



### 1.3.6 Authority for Use Airside – Identification

- AUA labels must be placed on the bottom left corner of the front windscreen. If the AUA label cannot be affixed to a windscreen, the label must be in a waterproof Permit Holder located in an appropriate visible position.
- Misuse of Authority to Use Airside (AUA) label/s may result in withdrawal or suspension of Airside Use privileges, or an infringement notice.
- You are responsible for updating your vehicle registration and insurance details: these details must be identical to the corresponding label affixed to your windscreen and/or motorised equipment.

AUA labels are not permitted to be transferred between vehicles.

Expired Brisbane AUA's or AUA's from other airports must be removed.

All vehicles using the airside must be readily identifiable by the clear display of company operator logos on both sides of the vehicle's exterior. The logos must be readable from a distance of 15 metres.

## 1.4 Aviation Security Identification Card (ASIC)

At Brisbane Airport drivers must wear an Aviation Security Identification Card (ASIC) prominently displayed in the region of the chest and carry their current State drivers licence and Authority to Drive Airside at all times.

## 1.5 Basic Safety Rules and Procedures

Drivers must comply with the Brisbane Airport Airside Vehicle Control Handbook. The most up to date Airside Vehicle Control Handbook can be located in the [Airside Driving Centre](#) on the Brisbane Airport website.

- All drivers are to ensure that they remain current and up to date with the latest amendments to the latest edition of Brisbane Airports Airside Vehicle Control Handbook.
- Vehicles must not be driven in a manner likely to endanger the safety of any person.
- Unauthorised drivers detected driving in an area beyond the parameters of the category of ADA issued to drive airside will have their Authority to Drive Airside immediately suspended, as this is a serious safety breach.

**All vehicles are required to STOP at all stop signs and LOOK.**

## 1.5.1 Speed Limits

Drivers must obey all regulatory signs and adhere to the following speed limits:

Location	km/h
Baggage Make-Up Areas (common user facilities e.g. International Terminal and Centre User Satellite at the Domestic Terminal)	10km/h
Within 15 metres of an aircraft	10km/h
Shared zones - On the Airside road in front of the Domestic and International Terminals, the General Aviation Apron and the Logistics Apron	20km/h
Perimeter roads	20km/h or as posted in specific areas
On the Logistics Apron vehicles are not to be driven along the former terminal frontage, but are to proceed within the marked lanes on the Apron located behind parked aircraft.	20km/h
Elsewhere on the apron area eg Taxiway Mike, H2S, H2N	20km/h
Taxiways	as required
Runways	as required
When "Low Visibility Procedures" are declared by ATC	20km/h maximum

This speed limit is rigorously enforced. These areas are also designated as Shared Zones, where there are a large number of personnel operating in the area. Drivers must be aware of the potential for pedestrians. Shared Zone areas are clearly signposted and monitored by speed detecting laser equipment.

In any event, where a speed limit is indicated by a sign, this shall be the speed limit for the area (*This speed limit is the maximum speed for ideal conditions and must be reduced when driving and visibility conditions deteriorate*).

## 1.5.2 Baggage Make-up Areas (BMA) - Common User Facilities

The BMA is a high traffic working area with large numbers of vehicles and personnel operating simultaneously within close vicinity. A high level of situational awareness is required to be always aware of your surroundings. Safety is a priority.

Drivers must obey all signage and pavement markings and adhere to the speed limit, at all times. The speed limit in the BMA is 10 km/h and is enforced and monitored regularly by BAC.

Within the BMA, the road system is marked as one-way directional flow and directional markings must be followed at all times (ITB-BMA Layout). Failure to abide by the speed limit and/or not comply with any road markings endangers both yourself and fellow workers - appropriate action will be taken against speeding drivers (refer penalties table).

The Northern ITB BMA Access Road is a two-way road with the following restrictions;

- Max speed 10 km/h
- Maximum of 4 (four) x Dollies/Barrows/LD3's
- Maximum 1 (one) x Low Profile

**The above restrictions apply to BOTH the Northern and Southern ITB BMA Access Roads.**

Figure 2 ITB BMA Access Roads

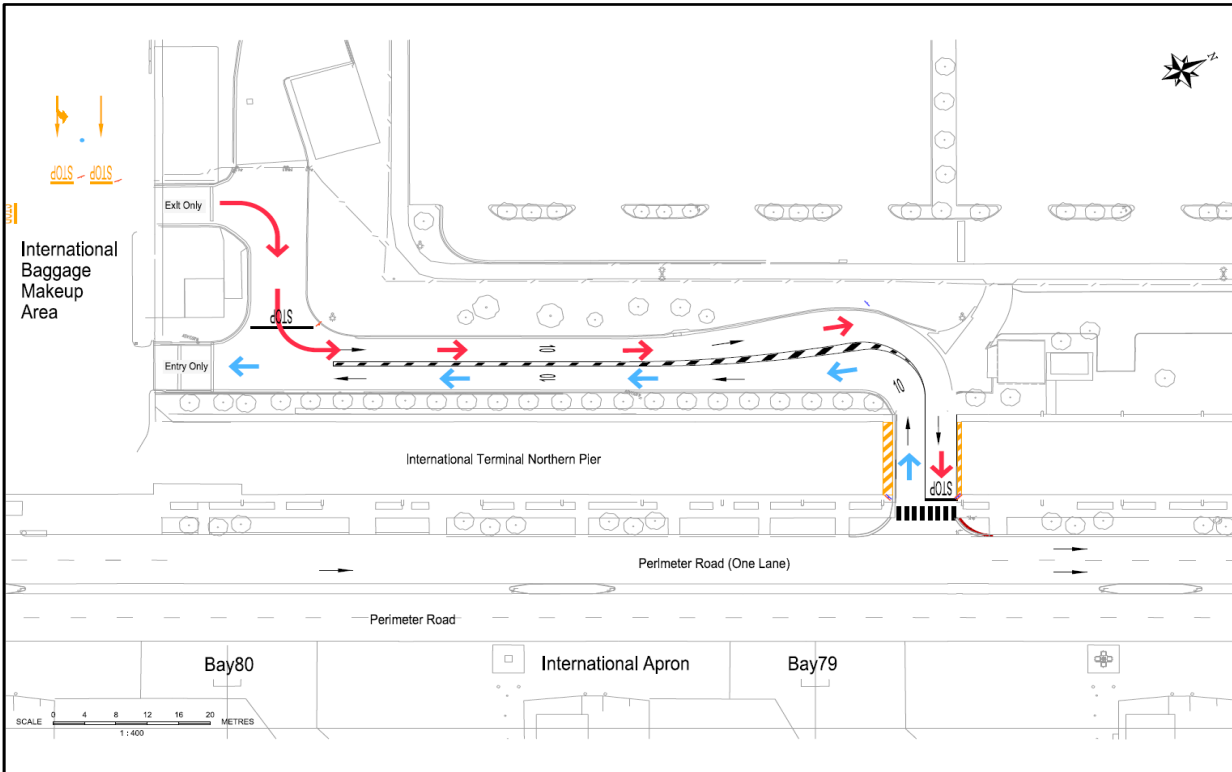

### 1.5.3 Airside Speeding

The Australian Federal Police (AFP) may be invited Airside to assist in the enforcement of speed limits. The AFP and BAC Airside Operations Centre Staff will use the appropriate equipment to detect persons speeding.

Figure 3 Shared Zones Domestic and International Terminals Airside



These signs are located airside at the Terminals. They advise drivers of the speed limit and remind all that the area is shared by pedestrians and vehicles.

Failure to abide by the speed limit endangers your fellow workers and passengers, and appropriate action will be taken against speeding drivers.

Figure 4 International Terminal



These typical speed limit signs (pole mounted and on road surface) indicate where 20 km/h speed limit commences.

## 1.6 Posted Height under Aerobridges

Figure 5 Aerobridge Height



The posted height under the aerobridges at both the International Terminal and the Domestic Terminal is **3.8 metres**.

All vehicles/equipment over the height of 3.8 metres must have the height clearly displayed to the operator.

Example of a vehicle height display inside the cabin of a vehicle over 3.8 metres in height:

Figure 6 Height Display





## 1.7 Seatbelts

Where fitted, seatbelts must be worn by occupants of vehicles when operated on the airside. The driver of the vehicle is responsible for all occupants.

**PENALTY: Driving Airside without wearing a seat belt where fitted may result in a loss of 3 (three) penalty points.**

No person shall ride on or operate a vehicle when the passenger/cargo load is in excess of the designated capacity of that vehicle (excluding buses).

**PENALTY: Carrying a passenger when there is no seat provided (excluding buses) may result in a 1 (one) month ADA Suspension and a loss of 6 (six) penalty points.**

## 1.8 Drug and Alcohol

Vehicles must not be driven when drivers are affected by alcohol or drugs to an extent that would preclude that driver lawfully as per CASA Regulations Part 99.

BAC Airside Safety Officers are authorised to prohibit any person entering the airside area if they reasonably believe that person is under the influence of alcohol and/or drugs. The Airside Operations Centre will contact the driver's organisation for follow up under the Drug and Alcohol Management Plan (DAMP).

## 1.9 Mobile Telephones

To operate a mobile phone airside whilst driving requires the phone to be secured in a cradle and have a hands-free function.

**PENALTY: Operating a phone that is not handsfree while driving airside may result in a 1 (one) month ADA suspension and a loss of 4 (four) penalty points.**

### 1.9.1 Personal Entertainment Audio Devices

Personal entertainment audio devices must not be utilised whilst operating a vehicle on the Airside.

**PENALTY: Operating a personal entertainment audio device whilst operating a vehicle may result in a 1 (one) month ADA suspension and a loss of 4 (four) penalty points.**

## 1.10 Safety in the Vicinity of Aircraft

To ensure safe operation of vehicles in the vicinity of aircraft on Brisbane Airport, drivers:

- Must have a rotating beacon/s operating on the vehicle;
- Must give way to pedestrians at all times;
- Must give way to moving aircraft at all times even when the aircraft are under tow;
- Must stay well clear of aircraft when their red anti-collision beacons are operating;
- Must not use vehicles to service, load or unload an aircraft unless a representative of the aircraft operator or their agent is present to direct the movements of that vehicle;
- Must not operate a vehicle in reverse in the vicinity of aircraft unless under the guidance of another person or unless he/she has established it is absolutely safe to do so;
- Not drive vehicles within 3 (three) metres of a parked aircraft, except when required for the servicing of that aircraft;
- Keep vehicles a minimum of 15 (fifteen) metres clear of refuelling aircraft; and
- Must not drive within 15 (fifteen) metres of an operational aircraft you are not associated with.

The only vehicles permitted on the Aircraft Stands are:

- Vehicles with operational amber rotating beacon/s;
- Vehicles directly connected with the refuelling or servicing of an aircraft;
- Vehicles carrying heavy or awkward articles of freight which cannot be handled by normal freight trolleys;
- Vehicles directly associated with aerodrome works;
- Vehicles approved by BAC; and
- Ambulance, Police and Fire vehicles in emergency circumstances and under escort (Airport Rescue Fire Fighting Units excluded).

## 1.10.1 Situational Awareness

Situational awareness is being alert to all that is happening around you. Situational awareness can be affected by a number of things; stress, fatigue, work overload and work under load. The following techniques can help you and others stay aware:

- The use of mental pictures;
- Clear and open communication;
- Planning ahead;
- Keeping your eye on the bigger picture;
- Following standard operating procedures (SOP).

## 1.10.2 Fatigue

Fatigue impedes our judgment, decision making skills, response/reaction times and all aspects of human performance. Recognise the early symptoms of fatigue and do something about it.

**Obtaining sufficient restful sleep is the only answer to beat fatigue.**

## 1.11 Clearances to Operating Aircraft

Vehicle operators and personnel must always be aware of the dangers of “Jetblast”, “Propwash”, propeller injury and potential ingestion when in proximity to operating aircraft engines. Drivers of vehicles and equipment must ensure safe distances are maintained at all times to operating aircraft.

Typical aircraft are:

Aircraft Code	Maximum Wingspan	Aircraft Type Example
A	15m	e.g. Cessna 310
B	24m	e.g. Beechcraft 1900
C	36m	e.g. Boeing B737, de-Havilland Dash-8, Embraer 190, ATR - 72, Airbus A320
D	52m	e.g. Boeing B767, B757
E	65m	e.g. Boeing B747, B777, B787, Airbus A330, A350
F	80m	e.g. Antonov-124, C5B-Galaxy, A380

Aircraft manoeuvring must not be constrained and wingtip clearances to vehicles and equipment must be maintained. For aircraft manoeuvring in the vicinity of an Aircraft Stand, the aircraft to object required separation is:

Aircraft Code	Separation
A	3m
B	3m
C	4.5m
D	7.5m
E	10m
F	10m

For aircraft on an Apron Taxilane, the aircraft to object required separation is:

Aircraft Code	Separation
A	4.5m
B	4.5m
C	4.5m
D	7.5m
E	7.5m
F	7.5m

For aircraft on a Taxiway, the aircraft to object required separation is:

Aircraft Code	Separation
A	8m
B	8m
C	8m
D	11m
E	11m
F	11m

Vehicles and equipment must remain at least 15 metres clear of the engines of an operating aircraft unless specifically associated with the servicing of that aircraft.

If the vehicle, the operator or personnel are associated with servicing of an aircraft, then they are responsible for maintaining safe clearances and work practices in accordance with their company operating procedures and instructions. Aircraft characteristic manuals also provide detail on engine intake and exhaust clearance zones.

In addition, Civil Aviation Order 20.9 requires the following clearances to the rear of, and, within a 15 degree arc either side of the exhaust outlet of an operating aircraft engine:

Engine Type	Power Condition	Minimum Distance
Turbo-prop	At or below normal slow taxiing power	15m
Turbo-prop	At power used to initiate movement of a stationary aircraft	23m
Turbo-jet	At or below normal slow taxiing power	30m
Turbo-jet	At power used to initiate movement of a stationary aircraft	46m

## 1.12 Red Anti-Collision Beacons and/or Strobes on Aircraft

The red anti-collision beacons and/or strobes on aircraft, when activated, indicate that the aircraft is:

- Operational and the crew are in the cockpit; and/or
- About to start up; and/or
- About to be pushed back, or towed.

Anti-collision beacons may be fitted on either the top or bottom of the aircraft, or both. An indication that an aircraft is about to activate its anti-collision beacons is;

- No vehicles will be left servicing the aircraft;
- A pushback tug or power push unit will be attached; and
- The wheel chocks will be removed.

If you are unsure if an aircraft is about to pushback/start-up, **STOP** and wait, or take another route.

## 1.13 Parking of Vehicles

Figure 7 No Parking Area – Use Parking Areas Adjacent Perimeter Road



Category 1 ADA holders are permitted to park within the parking areas adjacent the perimeter road, in the cases whereby no other parking is provided.

Vehicles must not be parked where they will obstruct aircraft, other vehicles, access to eyewash stations, emergency fuel stops, pedestrians or any access doors from terminals or airport buildings. On Apron areas vehicles and equipment must only be parked within the defined equipment parking areas.

Vehicles left unattended and turned off on the Aircraft Stand must be left in the park position (automatic) or in gear (manual) with the handbrake on.

Vehicles containing potential hazardous material such as aircraft fuel tankers must be stored in designated areas only. Fuel tankers must not be stored adjacent to terminal buildings or other publicly accessible zones.

**PENALTY: Failure to park equipment correctly in an equipment staging or storage area may result in a loss of 3 (three) penalty points.**

## 1.14 Passenger Pathways

Figure 8 Pedestrian walkway



To ensure safe operation of pedestrian's airside on Brisbane Airport, drivers:

- Must give way to pedestrians at all times;
- Not infringe on the passenger flow to and from an aircraft.

**Under no circumstances is equipment to be parked on passenger pathways.**

## 1.15 Emergency Eyewash Stations

Figure 9 Eye Wash Station

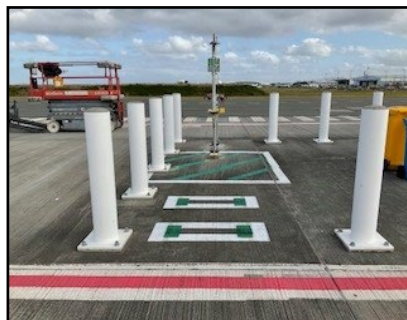
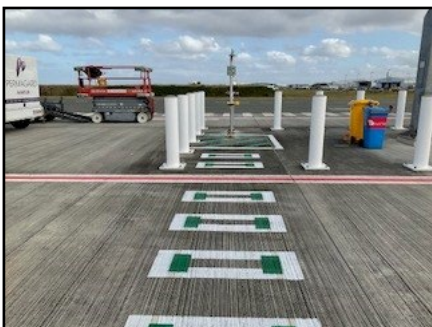

**Under no circumstances is equipment to be parked over eye wash station markings. Airside workers must have unimpeded access to eye wash stations.**

## 1.16 Emergency Fuel Stop Button

In case of an emergency all ramp crew no matter their normal job have authority and indeed responsibility to activate the Fuel Emergency Stop System to shutdown fuel flow.

You do not have to ask for authority or check with anyone if in your judgement you believe a real danger exists. Do not hesitate and take action. Activate a fuel shutdown by pressing one of the Red Fuel Emergency Stop Station Buttons and then notify refuelling staff as soon as possible.

There will be no recrimination or embarrassment if you are wrong. It is much better to be safe than sorry due to the significant potential risks associated with flammable fuel flow in the busy aircraft apron ramp environment.

**DO NOT RESET** the Fuel Emergency Stop Button under any circumstances once activated, even if you later realise there is no emergency. Fuel Emergency Stop Buttons must only be reset by JUHI staff.

As a backup to the hardwired emergency fuel stop station buttons at each apron bay, radio operated fuel emergency stop buttons are also located on each of the fuel hydrant-dispensing vehicles, mainly for use by

the refueller. These buttons are located on the back of the vehicle cab on the driver's side and on the elevating platform.

Figure 10 Emergency Stop Sign



Figure 11 Emergency Stop on Vehicle



## 1.17 Vehicle Lighting - General

Vehicles intended for use on the Aprons must have an amber rotating beacon/s mounted on top of the vehicle as to provide 360 degree visibility to pilots and others, the presence of vehicles or mobile plant on the Movement Area - this includes Aircraft Stands.

Between sunset and sunrise or in conditions when visibility is less than 800 metres, vehicle lighting must be switched on (low beam) and tail lights operating.

High beam is not to be used Airside.

## 1.18 Low Visibility Conditions - (Fog or heavy rain)

When visibility is reduced to 2400 metres (the distance from the Tower to the Runway 19L Threshold) visibility conditions determined by Air Traffic Control are the visibility conditions that apply to the whole airside.

When aircraft movements are in progress during low visibility conditions, vehicular movements on the Manoeuvring Area shall be restricted to those vehicles under the control of ARFFS personnel, BAC Airside Safety Officers and other vehicles when escorted by an Airside Safety Officer. For all low visibility conditions non-essential vehicles will not be permitted on the Manoeuvring Area.

When visibility is reduced to 1500 metres the following shall occur:

- The ADM will notify tenants of reduced visibility;
- All non-essential vehicles operating on the airside will cease operations;
- The operation of vehicles essential to continued aircraft operations shall be minimised and kept under strict movement control of your respective Ramp Supervisor;
- Airside speed limits are reduced to 20km/h; and
- Only vehicles essential to aircraft operations gain airside access.
- Taxiway Hotel 3, Taxiway Hotel 4, Taxiway Mike and Taxiway Lima are not to be crossed by vehicles during declared low visibility conditions.

**PENALTY: Vehicles crossing a live taxiway during Low Visibility procedures will result in a 2 (two) month ADA Suspension and loss of 8 (eight) penalty points.**

Visibility reduces to between **150** and **100 metres** the following shall occur:

- The Airside Operations Team notifies the JUHI that they now are required to put on their red flashing light as visibility has dropped below 150 metres. Escorts are to be provided – permitting the Airside Operations Centre has the staff to perform this function.

Visibility reduces to **below 100 metres**;

- The Airside Operations Centre will notify tenants of reduced visibility;
- The apron areas of the airport are closed to all airside vehicle movement except for the Airside Operations Centre staff or emergency services vehicles under the escort of an Airside Safety Officer or ARFFS vehicles attending a declared emergency.

When visibility conditions improve the above will be done in the reverse as they appear.

## 1.19 Thunderstorm Warning System

A Thunderstorm Warning Alert System has been installed across apron areas and hangars at Brisbane Airport. The systems are activated in collaboration with Qantas and Virgin Australia, providing a consistent warning alert system across the airport at any one time. The system, consisting of white and blue lights accompanied with an audible siren, is designed to provide information to airside operators regarding the proximity of Thunderstorms to the airport. Based on the information provided by the Thunderstorm Warning Alert System, operators should refer and abide by their individual company policy and procedures regarding Thunderstorms.



10 Nautical Mile  
Thunderstorm Alert  
White strobe light activated

3 beeps, 2sec quiet,  
3 beeps, 2sec quiet,  
3 beeps and then quiet for the remainder of the alert

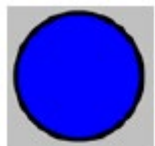

5 Nautical Mile  
Thunderstorm Alert  
Blue strobe light activated

Blue Strobes + Continuous repeating horn.  
(3beeps, 2sec quiet, 3 beeps etc.)

When this system is activated, it does not mean the airport is closed. Each respective organisation may have designed their individual WHS procedures for this system, please adhere to them.

### 1.19.1 WHS Procedures

This system does not mean the airport is closed. Each respective organisation may have designed their individual WHS procedures for this system, please adhere to them.

## 1.20 Foreign Object Debris (FOD)

The dynamic nature of the airside environment is such, that no-one would argue FOD and aircraft do not mix.

### 1.20.1 Loads Secured and Covered

Drivers must ensure all vehicles (Utes, open trays, buggies, aircraft under tow etc) that have the potential to and/or are capable of carrying loose material (such as tools, equipment, garbage, wastepaper, components or other materials etc.) when carrying such material airside, the load is adequately covered and secured to prevent spillage or FOD. Covers or nets must remain within the vehicle at all times to be accessible when required for travelling airside with a load. All aircraft doors must be closed whilst under tow.

**PENALTY: Failure to secure load or equipment may result in a 1 (one) month ADA suspension and a loss of 4 (four) penalty points.**

## 1.20.2 Rubbish Lids

All vehicles fitted with rubbish bins must have a secure lid to ensure FOD does not litter Apron areas and airside roads.

**PENALTY: Vehicle operators not complying with this requirement may have the vehicles AUA removed and a loss of 3 (three) penalty points.**

## 1.20.3 Responsibility for FOD

It is the responsibility of ALL airside personnel to remove FOD from the airside.

**PENALTY: Personnel failing to remove identified FOD may result in a loss of 1 (one) penalty point.**

## 1.20.4 Timber / Plastic Pallets Airside

All pallets are prohibited from entering the airside unless the pallet is being loaded onto an aircraft. When timber / plastic pallets are abandoned airside, this causes significant risk during storm events, as well as increasing the chances of Foreign Object Debris (FOD) within the airside area. In addition, these pallets pose a Work Health and Safety (WHS) risk due to the potential to cause trips and/or falls and are a haven for rodents which can attract dangerous wildlife. Monitoring the presence of timber / plastic pallets airside will be undertaken by the Airside Operations.

**PENALTY: Personnel failing to remove timber / plastic pallets from the airside (unless being loaded onto an aircraft) may result in a loss of 3 (three) penalty points.**

## 1.21 Towing of cargo and equipment

Drivers towing freight or baggage:

1. Tow Hitches must have safeguard features such as spring loaded, collared pin or locking pin.
2. Must not operate with a train of any rolling stock in excess of six (6) for the perimeter road.  
Note: ITB BMA max 4 barrows or 1 low profile.
3. Must ensure that dollies being towed at night have reflective surfaces
4. Must remove all loose/unused shrink wrap and dispose of in a safe manner to avoid creating a hazard
5. Must ensure that loads do not exceed the limitations on equipment

## 1.22 Vehicle Escort/Supervision

- Must ensure that loads do not exceed the limitations on equipment
- Escorted/supervised vehicles must drive a sufficient distance behind a vehicle travelling in front of you so you can, if necessary; stop safely to avoid a collision. A driver should drive at least two (2) seconds behind the vehicle in front in ideal conditions.
- It is the escorting driver's responsibility to ensure the driver of the escorted/supervised vehicle is aware of the requirement to maintain the above distances and tracking.

### 1.22.1 To drive unescorted in the airside environment, a driver must have:

- A current and valid ASIC
- A current and valid ADA
- A current and valid AUA



A non-AUA vehicle must be escorted by an AUA equipped vehicle driven by an appropriate category of ADA licence holder.

BAC Airport Operations Centre, upon request, may provide an escort service for a vehicle not authorised to be driven airside, or a driver not authorised to drive Airside. Charges apply.

The Airside Safety Officer Escort Form can be downloaded from the Airside Driving Centre section of the Brisbane Airport website.

BAC Airside Safety Officers or an ADA holder with the appropriate Category ADA may provide escort or supervision by:

- Driving an authorised vehicle as an escort for the escorted/supervised vehicle;
- Riding in the escorted/supervised vehicle; or
- Accompanying the escorted/supervised vehicle on foot.

## 1.23 Electronic Security Gates

Figure 12 Airside Security Gate

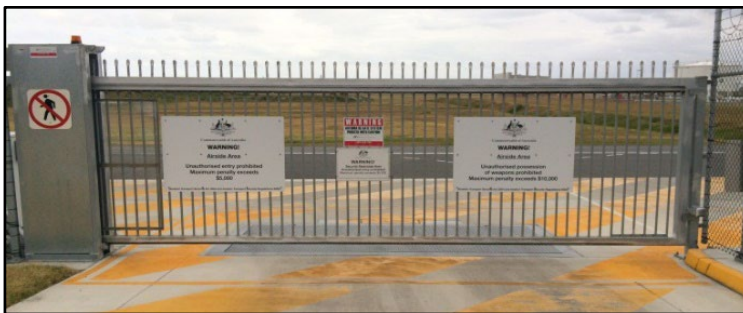

The electronic security gates provide access to the Security Restricted Area (SRA) of the Airport.

Drivers are required to ensure electronic security gates have completely closed both on entry or exit of a Security Restricted Area. Only authorised persons on duty holding an Aviation Security Identification Card (ASIC) are permitted entry to the Security Restricted Area.

## 1.24 No Smoking

The entire airside at Brisbane Airport is designated as a “**No Smoking Area**”. Smoking is prohibited in all airside areas including inside vehicles that are Airside.

**PENALTY: Withdrawal of access privileges. Please refer to the “Conditions of Issue” for BAC Access Cards.**

## 1.25 Instructions by an Authorised Person

Drivers must comply with instructions given by an Authorised Person.

A driver may be asked to provide a State, Territory or International Drivers Licence upon request from an Authorised Person; the driver must comply with the authorised persons request to present the State, Territory or International Drivers Licence with a 24-hour time period at the required location.

Where a driver:

- Has breached the Airside Vehicle Control Handbook at Brisbane Airport; or
- Has been involved in an incident such that driver must produce their State, Territory or International Driver's Licence and Authority to Drive Airside if a person having reasonable grounds asks to inspect them.

## 1.26 Perimeter Roads

Figure 13 Perimeter Road Markings

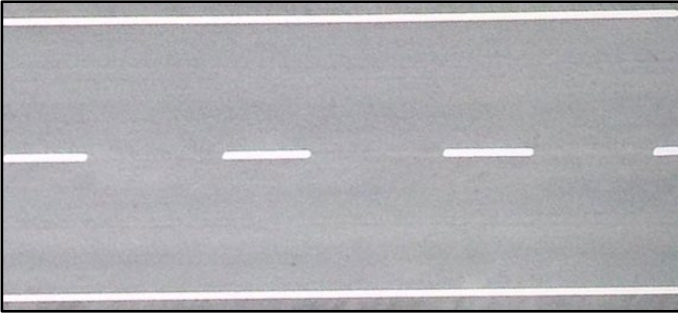

The Perimeter Road along the Terminals has white edge paint markings.

Vehicles must not traverse the perimeter road in reverse direction, with the exception of reverse parking into designated parking areas in the immediate vicinity.

**PENALTY: Traversing the Perimeter Road in reverse direction may result in a 1 (one) month ADA suspension.**

## 1.27 Painted Stop Signs

Figure 14 Painted Stop Signs



Stop signs are also painted on the ground.

## 1.28 Stop for Aircraft Markings

Figure 15 Stop for Aircraft Marking



'Stop for Aircraft' markings are painted on Apron service roads. Stop at the painted stop bar. All drivers must give way to aircraft, at all times.

## 1.29 Taxiway & Apron Taxilane Crossings

At a number of points along the airside Perimeter Road, there are crossings of operational Taxiways.

These crossings are at Taxiways:

- Hotel 3
- Hotel 4
- Lima
- Mike

There are also three crossings at operational Taxilanes:

- ITB
- Echo
- Delta 3

Vehicular traffic crossing these Taxiways/Apron Taxilanes must obey the warning and regulatory signs.

Stop, observe for aircraft approaching and only proceed when clear.

Taxiway Hotel 3, Taxiway Hotel 4, Taxiway Mike and Taxiway Lima are not to be crossed by vehicles during declared low visibility conditions.

**PENALTY: Vehicles crossing a live taxiway during Low Visibility procedures will result in a 2 (two) month ADA Suspension and loss of 8 (eight) penalty points.**

### 1.29.1 Live Taxiway Crossing

Figure 16 Live Taxiway Crossing Marking

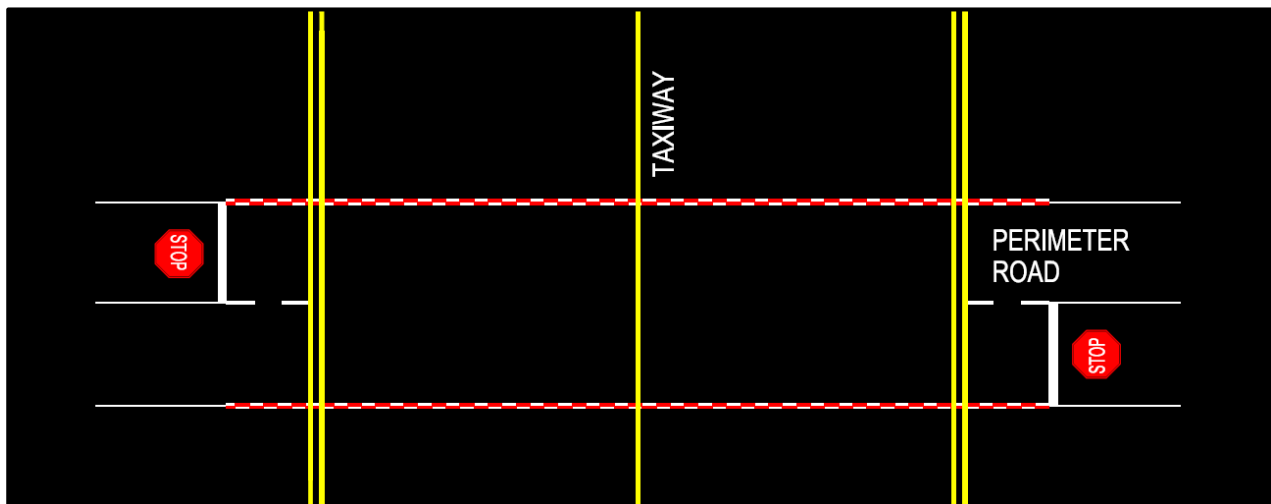

A crossing on a live Taxiway/Apron Taxilane is marked by a red and white zipper pattern on the pavement. Vehicles shall stop at the designated Stop Sign and give way to moving aircraft if they are approaching, then cross with care, allowing for jetblast or propwash.

Figure 17 Taxiway Crossing Stop Sign Example



Figure 18 Warning sign – Hotel 3



### 1.29.2 Stop and Look at Taxiway / Apron Taxilane Crossings

All vehicles must **stop** at the STOP sign prior to any Taxiway / Apron Taxilane crossing **and look**. Failure to stop is considered a major safety breach. Immediate action will be taken against any Driver failing to stop.

**PENALTY: Failure to stop at a live Taxiway / Apron Taxilane crossing may result in a 1 (one) month ADA suspension and loss of 6 (six) penalty points.**

Figure 19 Live Apron Taxilane Crossing

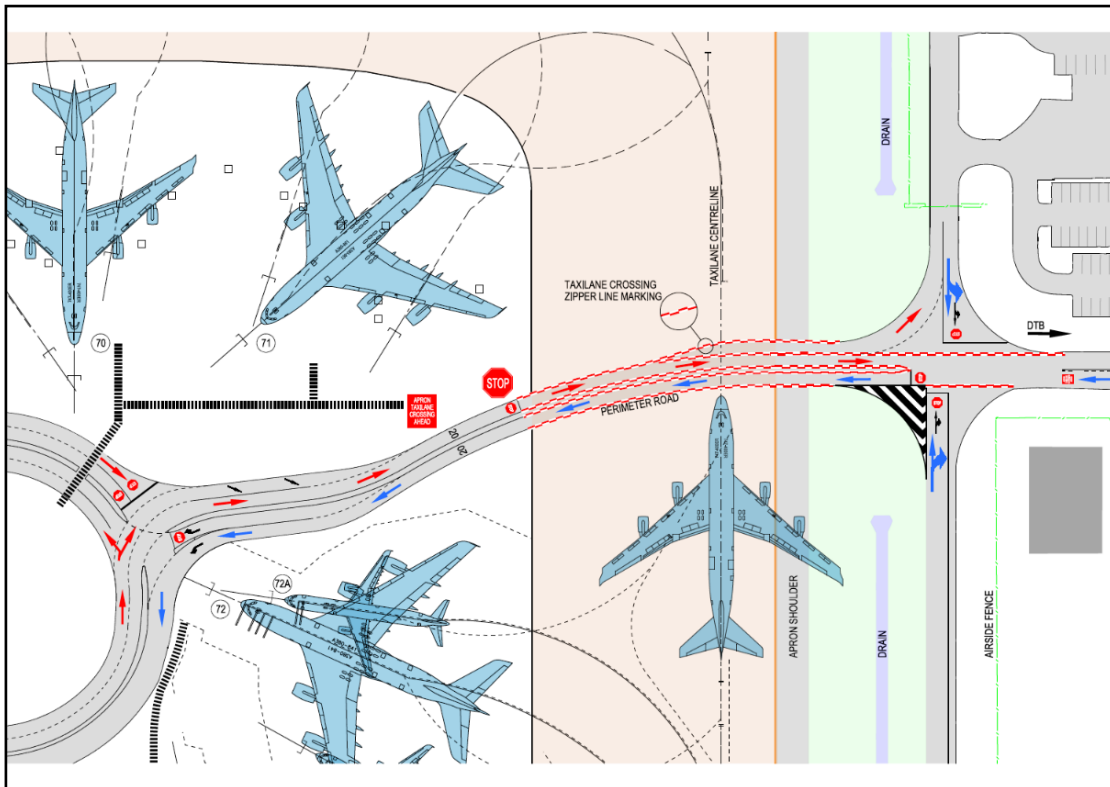

## 1.30 Vehicle/Equipment Parking Areas

### 1.30.1 Vehicle/Equipment Clearance Area, known as Staging Areas

Figure 20 Single Broken Red Line - Staging / Clearance



Vehicle/Equipment **Staging Areas** are defined by a **single broken red line**. Vehicles and equipment can be temporarily parked in this section while waiting to service an Aircraft. Please note vehicles and equipment must not operate in these areas any longer than 30 minutes prior to an aircraft arriving onto the bay.

These areas **must not** be used to store vehicles and equipment.

### 1.30.2 Vehicle/Equipment Storage Areas

Figure 21 Single Solid Red Line - Storage



Vehicle/Equipment **Storage Areas** are defined by a **single solid red line**, being areas where vehicles and equipment may be parked.

These areas must only be used for the storage of equipment that is not readily moved to the designated GSE areas for storage.

## 1.31 Safety Areas

Figure 22 Red Hatching Lines – Safety Areas

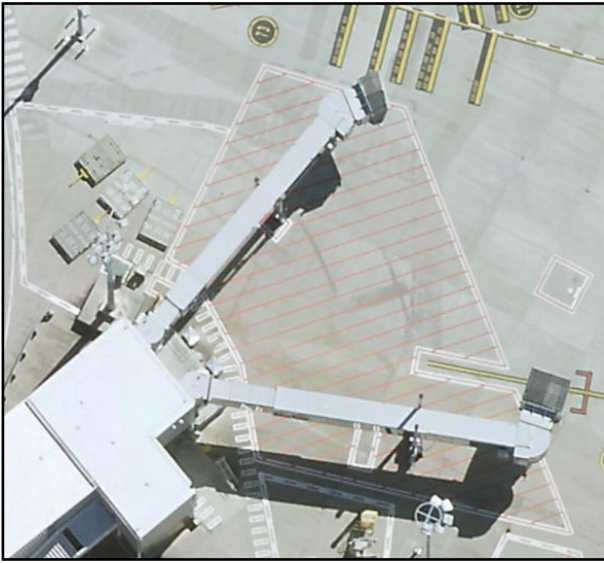

Figure 23 Red Hatching Lines – Safety Areas Spring Hydrant Access



The red hatching defines safety areas that vehicles and equipment must remain clear of at all times. Vehicles must not drive, park or stand in these areas.

## 1.32 Vehicle/Equipment Fuel/Oil/Sewage Spills

Drivers must report any vehicle, equipment or aircraft spill either to their direct supervisor or manager who will then report to the Airside Operations Centre (AOC), or report straight to the AOC.

**AOC (24/7 operations) can be contacted on 07 3406 3072.**

The spill must be assessed by an Airside Safety Officer before moving the vehicle/equipment.

In the event of a hazardous material spill, the Aviation Rescue Fire Fighting (ARFF) should be contacted immediately.

**ARFF (24/7 operations) can be contacted on 07 3860 3299.**

### 1.32.1 Sewage Spills

The Airside Operations Centre staff do not clean sewage spills. The Airside Safety Officer will close any bay to aircraft movements until such a time efforts have been made by the offending organisation to clean the spill or confirmation a contractor has been engaged to clean up. Only then, if it is safe to do so, will the Airside Safety Officer permit the aircraft to push back from the bay.

## 1.33 Aerobridge Emergency Stop Buttons

Figure 24 Aerobridge Emergency Stop Button

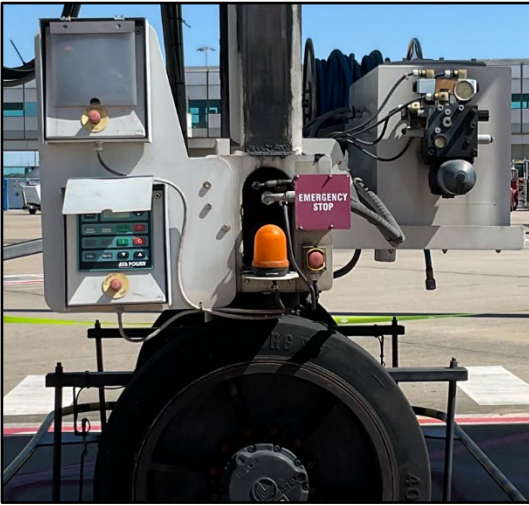

Figure 25 Aerobridge Emergency Stop Button



## 1.34 Other Areas of Caution on the Perimeter Road

### 1.34.1 General Aviation

Figure 26 Caution Aircraft Crossing



The above warning sign indicates that aircraft from the Royal Flying Doctor base cross the Perimeter Road. Yellow flashing warning lights have also been installed to advise of aircraft manoeuvring. Vehicles are required to give way to aircraft under tow.

## 1.34.2 Perimeter Road - Runway 19R/01L

Figure 27 ILS Critical Area



This sign is installed for authorised drivers travelling along the restricted section of the Perimeter Road passing the ILS (Instrument Landing System) critical area. The ILS critical area is an area of defined dimensions about the localizer and glide path antennas where vehicles, including aircraft, are excluded during all ILS operations.

**No stopping or turning permitted.**

Figure 28 below illustrated the Perimeter Road at the northern end of the Airfield, please note the following points:

- Traffic flow is via a single lane at the Eastern approach, crossing the Airport North Remote Apron
- All vehicles are to stop and give way to taxiing aircraft or aircraft under tow prior to crossing Taxilanes Delta 3 and Echo
- Traffic flow is divided at the Westend end at the decommissioned ARFF station

Figure 28 Northern Perimeter Road

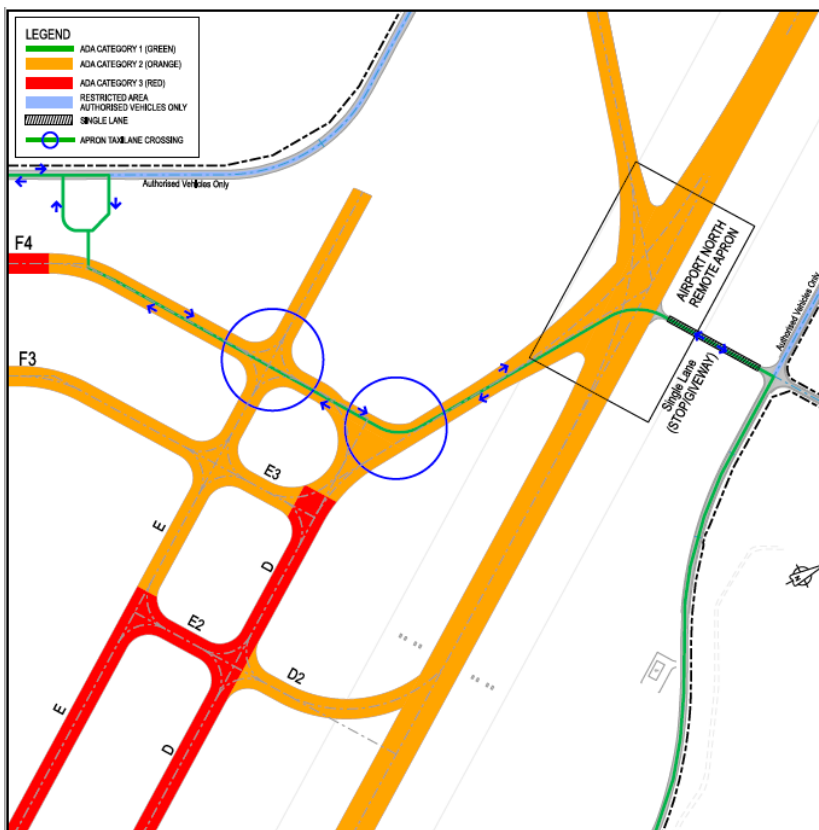



Figure 29 Authorised Vehicles Sign (ARFF, BAC, AFP, ASA & approved contractors) only beyond this point



Figure 30 Authorised Vehicles Pavement Marking

The sign in figure 29 and pavement markings in figure 30 above are found at various sections of the Perimeter Road. Access beyond is restricted to authorised vehicles (ARFF, BAC, AFP, ABF, ASA & approved contractors) with drivers holding the appropriate ADA category – refer Airside Drivers Map Appendix B.

## 1.35 Airside Animals

All animals (e.g. Dogs and wildlife) must be restrained inside a container or cage as per International Air Transport Association (IATA) specifications before being permitted entry to Airside. Once airside, animal/s are not to be released for any reason from their containers or cages.

The only exception to the above is Government Agency service dogs and assistance animals.

Airport Government Agencies may be excluded from this condition.

Permission will not be granted for contractors to take their dogs, etc. airside, even though they may be restrained on a leash.

Animals landside should also be tethered to prevent them gaining airside access.

For airside livestock transfers, compliance with Section 2.24 Livestock Transfers of the *BAC Aerodrome Manual* is required.

## 1.36 Unpaved/Grassed Areas

Unless expressly directed by an authorised person, the use of vehicles/equipment/aircraft on unpaved areas is not to be undertaken because:

- Airside drainage may not be readily visible;
- Drains are not marked;
- Minimum topsoil exists on the grassed areas;
- Mud, gravel, sand and grass would be tracked when returning onto the sealed paved areas and become a FOD problem for aircraft;
- Having a vehicle disabled or bogged within the Taxiway strips (the unmarked Taxiway strip 47.5 metres both sides of the Taxiway centre line) could create aircraft surface movement problems.
- Contractors undertaking airside works that require vehicles to be operated on unpaved areas will be required to have equipment and resources ready to undertake sweeping and cleaning of aircraft pavements that are crossed.
- Contractors may be required to restrict vehicle manoeuvring to defined routes.

Figure 31 Example of leaving paved areas resulting in mud, grass and gravel on taxiway



### 1.37 Works Limit Markers (Red/Orange Witches Hats/ Bollards)



When deployed by BAC or BAC contractors, these markers indicate areas not available to persons and equipment.

Note: Flashing amber lights are used at night to supplement witches hats.

**PENALTY: Unauthorised interference with Aviation safety devices deployed by BAC – Unserviceability Markers/Lights/Witches Hats may result in a 1 (one) month ADA suspension.**

### 1.38 Portable Movement Area Markers

Figure 32 U/S Red and White Banded Cone



Figure 33 Red Steady Lights Replace U/S Cones at Night

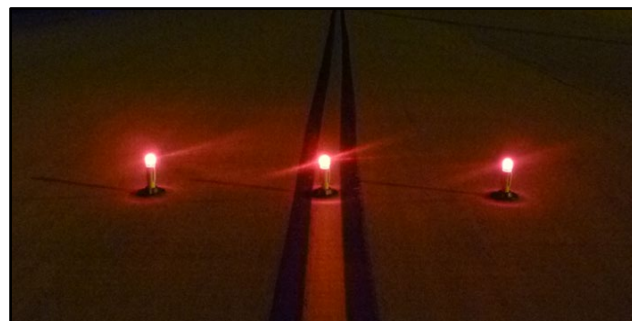

Unserviceability (U/S) Markers (Red & White Banded Cones) are used during daylight hours. Steady red lights are used at night or during low visibility conditions to supplement U/S markers.

Movement Area works – No aircraft or ground vehicle except a BAC Airside Operations vehicle may enter any part of the Movement Area that is marked off by either:

- Unserviceability markers; or
- Red Steady Lights

**PENALTY: Unauthorised interference with Aviation safety devices deployed by BAC – Unserviceability Markers/Lights/Witches Hats may result in a 1 (one) month ADA suspension.**

## 1.39 Bicycles, Tricycles, Motorised Skateboards

Bicycles, tricycles, motorised skateboards and similar devices are not permitted airside.

**PENALTY: Riding any of the above airside may result in a loss of 1(one) penalty point.**

## 1.40 Notifiable Incidents

A driver becoming involved in a vehicle/plant incident on airside:

- Causing personal injury; and/or
- Causes property damage; and/or
- Which may involve BAC in litigation

**MIUST: All drivers must immediately report details of the incident to their employer. The employer shall immediately notify BAC staff at the Airside Operations Centre on (07) 3406 3072, who will investigate. All drivers must co-operate with BAC in investigating the incident which has been notified.**

## 1.41 Disciplinary Action

A person who breaches the conditions of this Handbook or who drives in a negligent manner may have their Authority to Drive Airside suspended or withdrawn.

Authorised officers of BAC have the authority to control drivers on airside and any warnings issued by them will be recorded against the offending drivers.

For any specific incident, after full review and recommendation from the Airside Management team, the General Manager of Operations, at their sole discretion, may elect to impose a serious, but lesser penalty, for the infringement or incident. This discretion would be used rarely and only in specific cases

BAC may at any time withdraw or suspend an Authority for Use Airside or an Authority to Drive Airside.

## 1.42 BAC Penalties

See Appendix A – BAC Penalties Table

The BAC penalty points system allocates a maximum penalty for a range of prescribed airside driving offences, as set out in this section.

Each time a driver is reported for a breach of these rules for driving airside at Brisbane Airport, the driver will be notified, issued with a Penalty Infringement Notice by an authorised Airside Safety Officer and a record kept of the appropriate penalty points. The penalty applying to each type of breach is set out in the BAC Penalties Table in Appendix A.

Airside drivers who accumulate twelve (12) penalty points within the thirty six (36) month period of their ADA, will be provided with details of their offences and invited to show cause why their Authority to Drive Airside should not be withdrawn.

**PENALTY – A minimum of 1 (one) month suspension, to be assessed on a case by case basis.**

BAC will notify a driver's employer about the suspension or withdrawal of an ADA, or the issue of Penalty Infringement Notices under this section.

BAC will advise the driver in writing of the reasons for the determination and the duration of the withdrawal.

Drivers who receive a reduction in penalty points through violations will have said points available to them upon 36 months passing by.

## 1.42.1 Appeal Process

Airside drivers may challenge individual Penalty Infringement Notices, by writing to the BAC Airside Operations Centre within 14 (fourteen) days of the notice being issued and stating why the notice should be withdrawn.

The driver's response to the *show cause* notice will be considered by the Airside Operations Centre. A Driver's Authority to Drive Airside may be suspended pending this *show cause* process.

Upon making a determination to suspend or withdraw an ADA, BAC will advise the driver in writing of the reasons for the determination and the duration of the withdrawal.

If a determination is made to suspend an ADA for a specified time, the driver will be entitled to re-apply for an ADA after the expiration time. The ADA will not be automatically reinstated. The 8 (eight) or four (4) hour logbook must be completed, and ADA theory assessment undertaken.

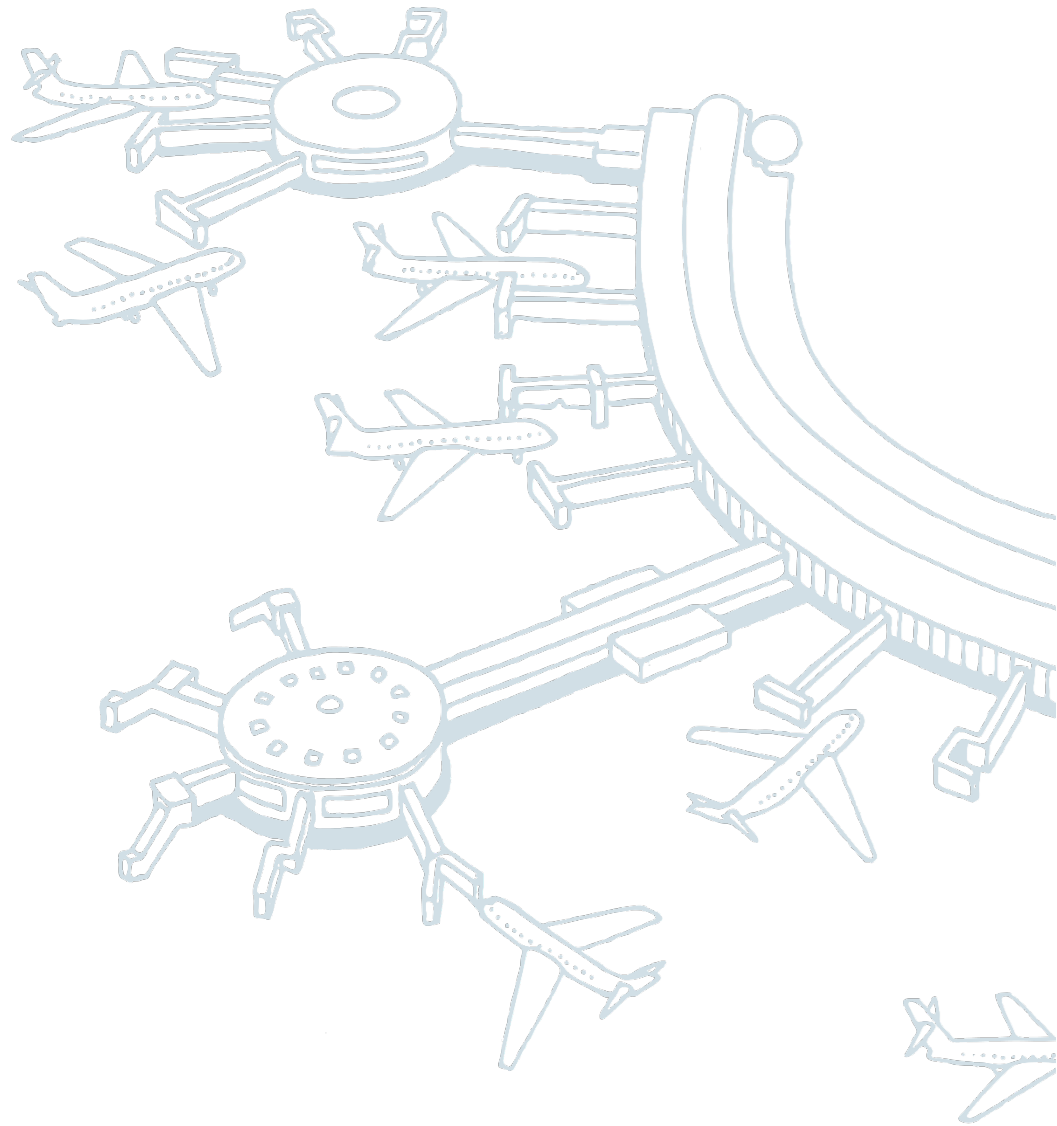

# CATEGORY 2 AUTHORITY TO DRIVE AIRSIDE

**Perimeter Roads** (Excluding Restricted Area accessed only by ARFF, BAC, AFP, ABF, ASA & approved contractors - refer Appendix B)

## Aircraft Stand

Applicants for Category 2 are required to read all of Category 1 plus this entire following section.

## 2. AIRCRAFT STANDS – RESTRICTIONS ON AREAS OF TRAVEL

### Legend

	Category 2 ADA
	Category 2A ADA
	Category 3 ADA

### 2.1 Domestic Terminal Apron

Figure 34 Orange Area Indicates Aircraft Stand at Domestic Terminal

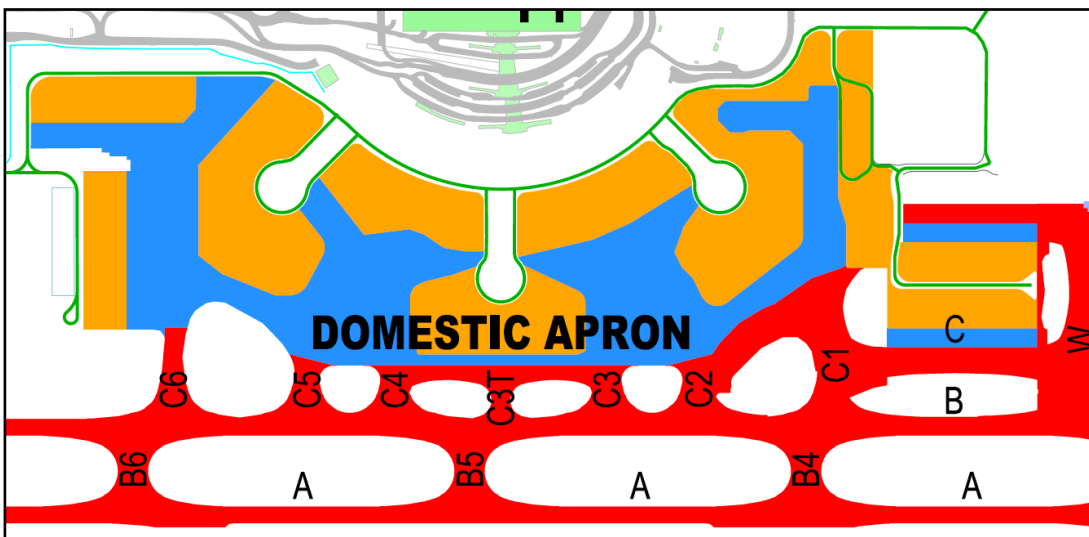
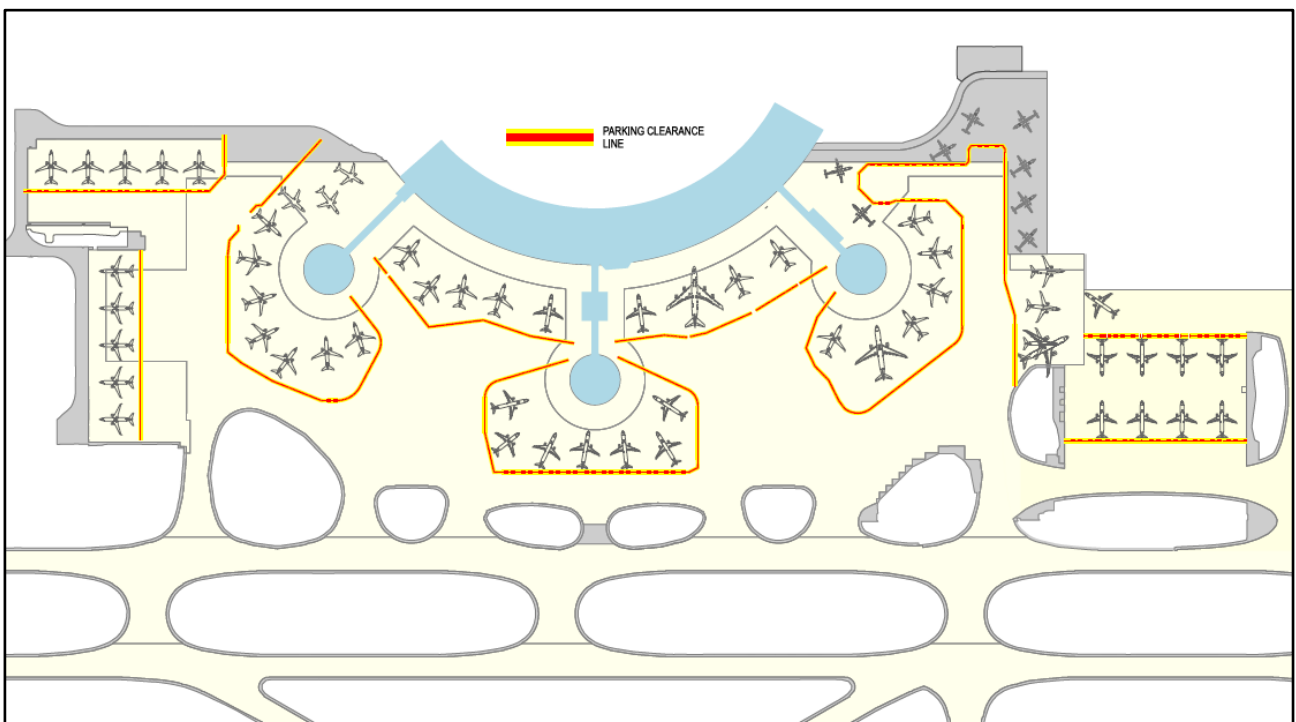

Figure 35 Aircraft Stand and Apron Areas are Separated by the 'Yellow Red Yellow' Parking Clearance Line



## 2.2 International Terminal Apron

Figure 36 Orange Area Indicates Aircraft Stand at International Terminal

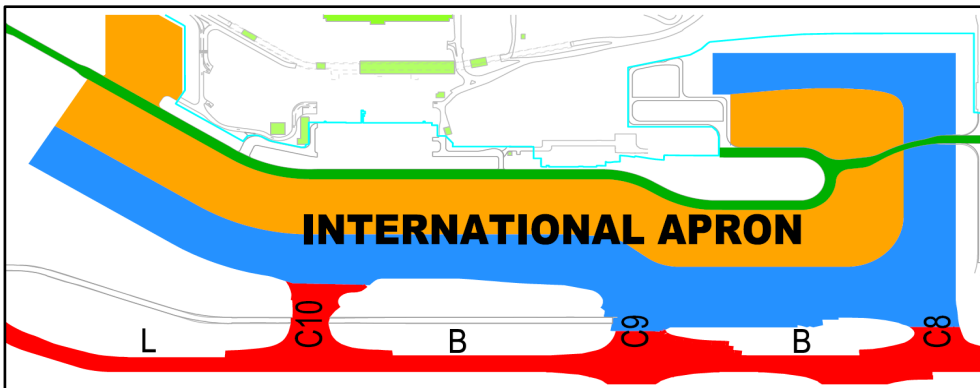
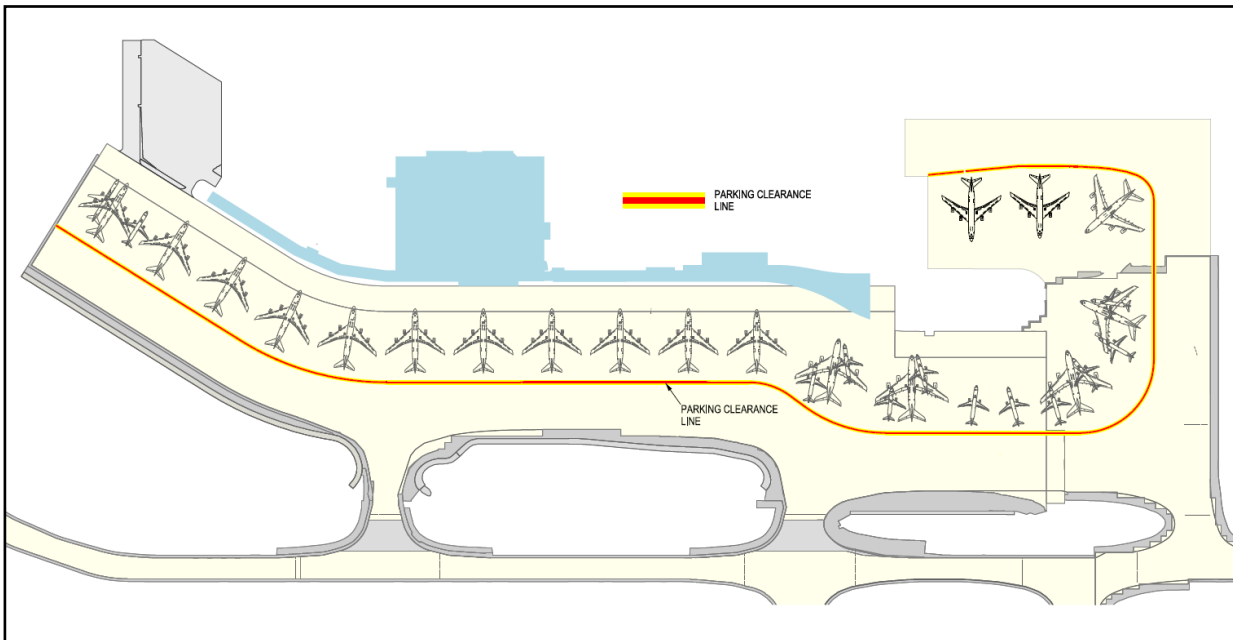

Figure 37 Aircraft Stand and Apron Areas are Separated by the 'Yellow Red Yellow' Parking Clearance Line



## 2.3 Logistics Apron

Figure 38 Orange = Aircraft Stand



Figure 39 Perimeter Road (Blue Arrow) Aircraft stand (Red Arrow)

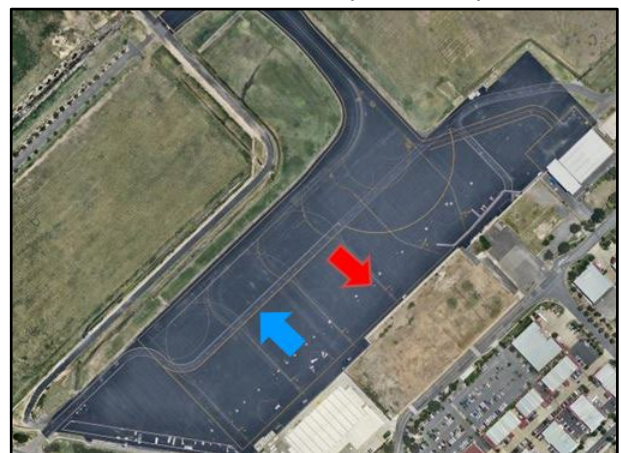

## 2.4 Airport South Parking Apron Requirements (Category 2 ADA or above)

Figure 40 Orange = Apron



Figure 41 The Apron Area are separated by the 'Yellow Red Yellow' Parking Clearance Line

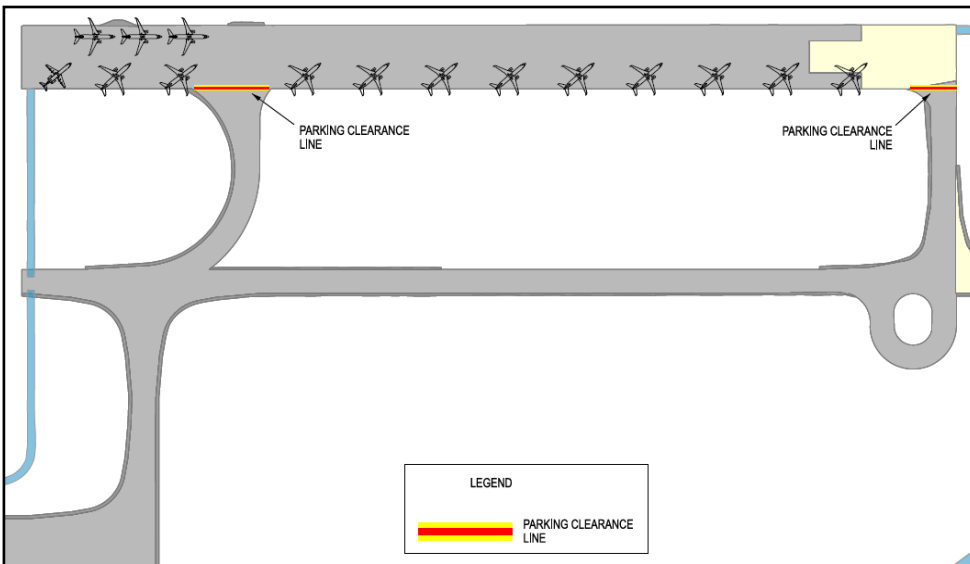

## 2.5 Taxiway Foxtrot 3 (TWY F3) Northern Taxiway Echo (TWY E) and Taxiway Echo 3 (TWY E3) Requirements (Category 2 ADA or above)

Figure 42 Taxiways Foxtrot 3, Northern Echo and Echo 3  
Orange = Apron





## 2.6 General Aviation Apron

The General Aviation Apron is only permitted to be accessed by a Category 2 and above ADA Holder. All vehicles must follow the white pavement markings of the service road.

To proceed beyond the parking clearance lines requires a Category 2A ADA and to proceed onto the live taxiway requires a Category 3 and above ADA.

All vehicles accessing the General Aviation Apron are to have a rotating amber beacon switched on at all times (applies both day and night).

Figure 43 General Aviation Apron

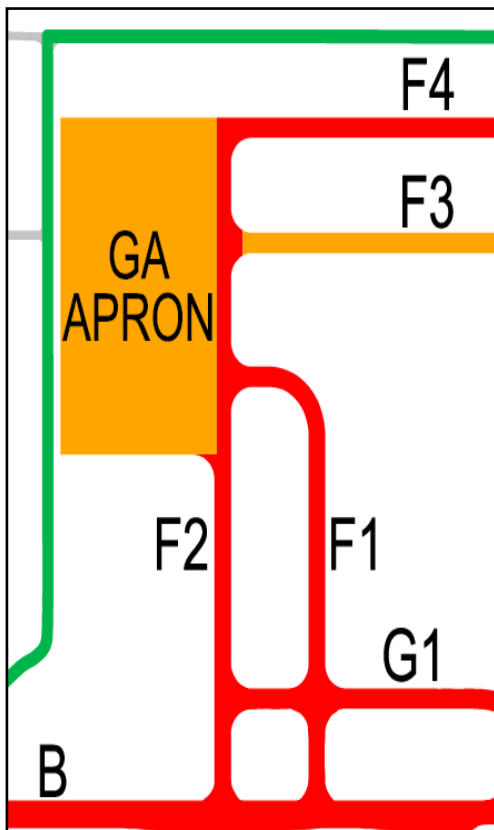
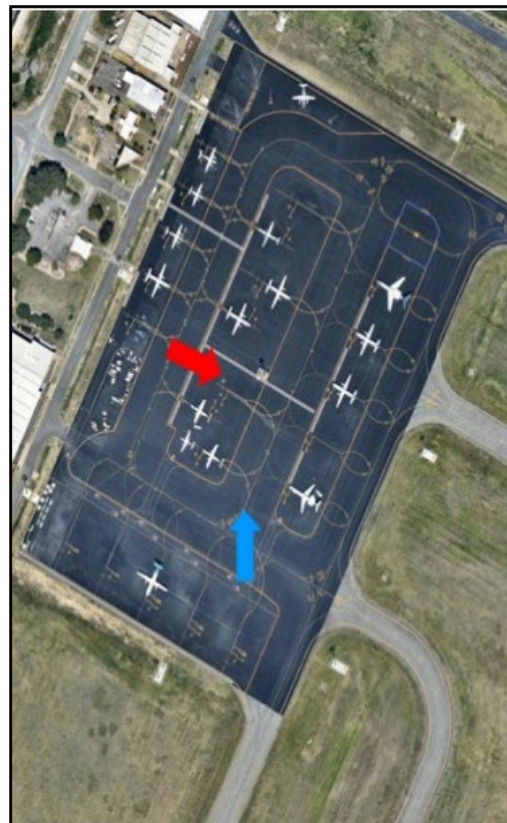

Figure 44 Apron Taxilane (Blue Arrow) Aircraft Stand (Red Arrow)



## 2.7 General Aviation Maintenance Area

Figure 45 Hotel 2 North and Hotel 2 South

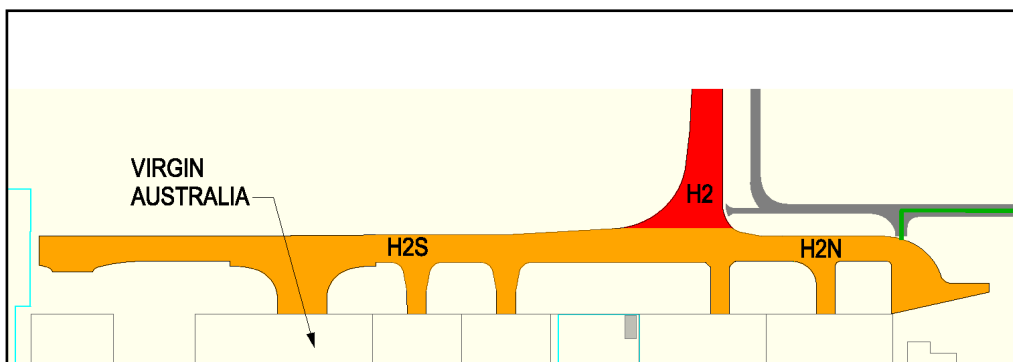
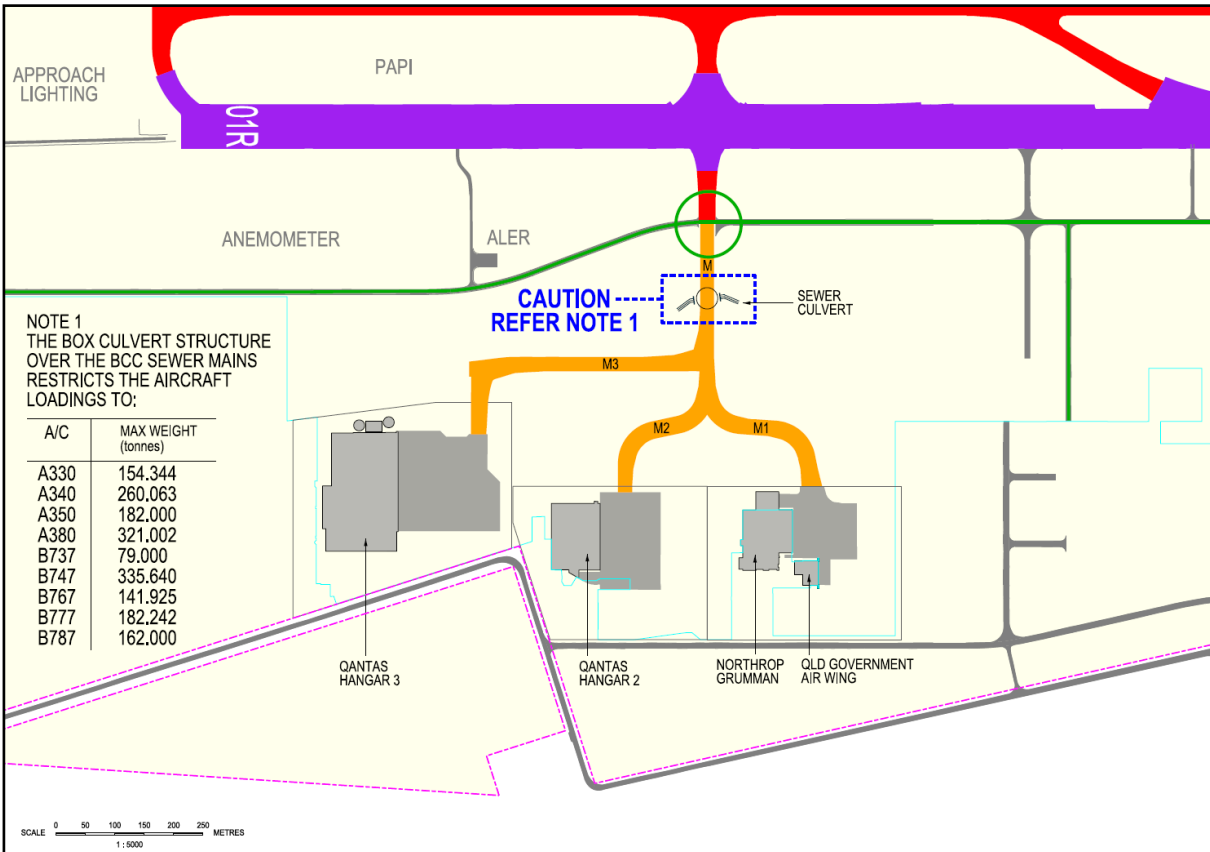

Figure 46 Taxiway Hotel



## 2.8 Qantas Maintenance Hangars

Figure 47 Qantas Maintenance Hangars



## 2.9 Taxiway Mike (TWY M) Requirements (Category 2 ADA or above)

Figure 48 Taxiway Mike



Figure 49 Taxiway Mike / Perimeter Rd



All drivers should be aware that TWY M is designated as an “Apron / Aircraft Stand” east of the perimeter road to the maintenance facilities. TWY M between the Perimeter Road and the 01R/19L Runway Strip is an active TWY and requires a Category 3 or 3RWY Authority to Drive Airside.

As a result, all drivers travelling along TWY M must hold a current Category 2, 2A, 3 or 3-RWY Authority to Drive Airside. When driving along the Taxiway, drivers are to drive on the left-hand side, as close as possible to the Taxiway high strength lines (double yellow).

To enhance safety, and to prevent unauthorised vehicles from entering the Runway Strip, all drivers except those towing aircraft must STOP in line with the signs as indicated:

Figure 50 Stop Signs



**PENALTY:** Failure to stop at the sign is a serious safety breach and may result in the loss of 6 (six) penalty points.

**PENALTY:** Unauthorised drivers detected driving on TWY's Mike, Mike 1, Mike 2 or Mike 3 will result in a 2 (two) month ADA suspension and loss of 8 (eight) penalty points.

**Drivers MUST give way to aircraft at ALL times**

Figure 51 Warning Stop Sign and Stop Pavement Marking – Taxiway Mike looking toward RWY 01R-19L



All vehicles coming from the hangars heading in a westerly direction must stop adjacent to the above sign. Drivers are then to check that it is safe to proceed. The Perimeter Road runs left to right.

Only **authorised vehicles and drivers** (Category 3 and above) are allowed to **enter** onto Taxiway Mike proper, **west** of the Perimeter Road and only with ATC clearance. The driver must be in communication with ATC to cross over the Perimeter Road.

Drivers using Taxiway Mike to gain access to the maintenance areas to the east, must be in the possession of a Category 2 and above ADA.

Figure 52 Taxiway Mike Entry Warning Sign



No vehicle is permitted to proceed past this sign under any circumstances, unless the driver has sought and been given clearance to do so from ATC.

Please note there are maximum weight limits for aircraft being towed on Taxiway Mike due to the box culvert structure over the sewer mains (refer to Figure 47).

## 2.10 Taxiway Hotel (TWY H) Requirements (Category 2 ADA or above)

All drivers should be aware that TWY Hotel 2 North and Hotel 2 South is designated as an “Apron / Aircraft Stand” for vehicles requiring access to the maintenance facilities. The remaining sections of TWY Hotel system is designated for aircraft movement ONLY.

TWY H is not to be used as a vehicle shortcut from the Perimeter Road to the maintenance facilities. Only authorised vehicles and drivers, which have sought and received approval from ATC are permitted to travel on TWY H2, H3 and H4. A Category 3 or 3RWY ADA is required.

150 metres North of TWY Hotel 3 is the access road (Hercules Rd) to TWY Hotel 2 North and Hotel 2 South. To access TWY Hotel 2 North and South, turn into Hercules Rd, and use the same access road upon return.

Figure 53 Signage for H2N and H2S



If safe to do so, e.g. no aircraft approaching or moving on the Taxiways, vehicles must use the **EASTERN SIDE** (hangar side) of the TWY Hotel 2 North and Hotel 2 South to gain access to the various maintenance facilities. Clearance from ATC is not required for movement along the eastern edge of TWY's H2N and H2S. A Category 2, 2A, 3 or 3RWY ADA is required.

Figure 54 Maintenance Facility Access Road

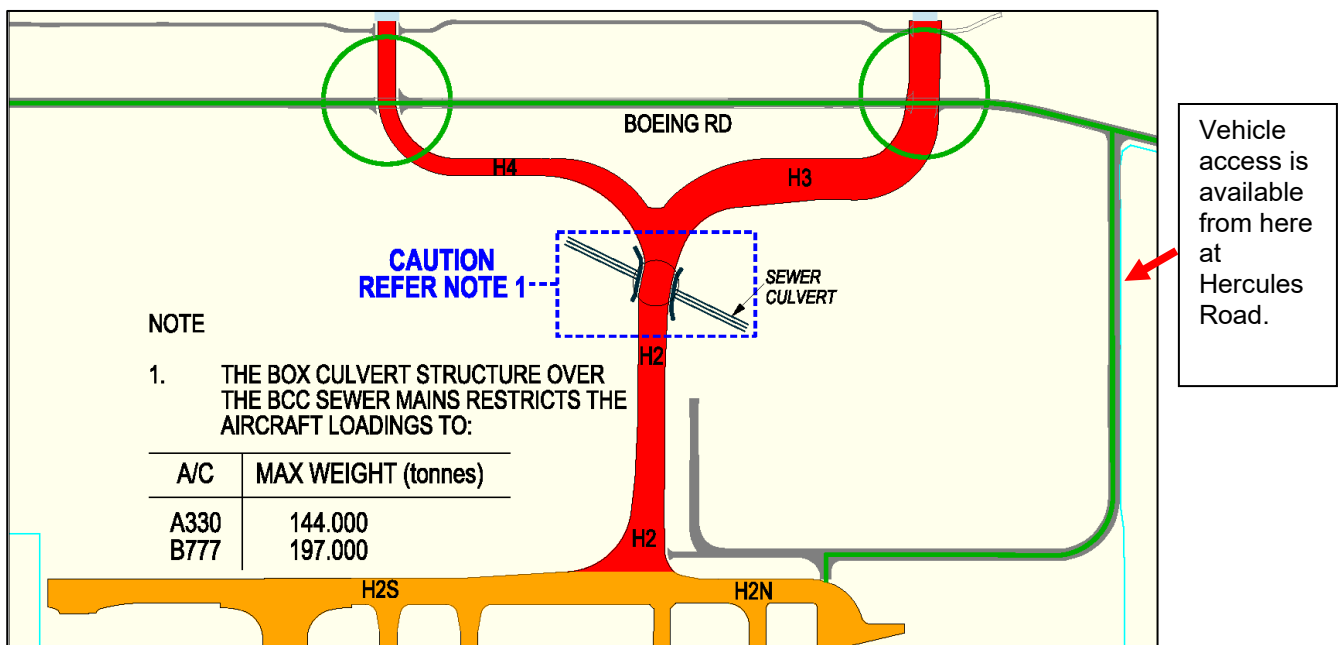

Please note there are maximum weight limits for aircraft being towed on Hotel 2 due to the box culvert structure over the sewer mains (refer to above figure 54).

**PENALTY: Unauthorised drivers detected driving on TWY's H2, H3 or H4 will result in a 2 (two) month ADA suspension and loss of 8 (eight) penalty points.**

## 2.11 Vehicles Cutting Across the Aprons

Vehicles are not permitted to take short-cuts across the Aprons or Apron Taxilanes.

Figure 55 Parking Clearance Line

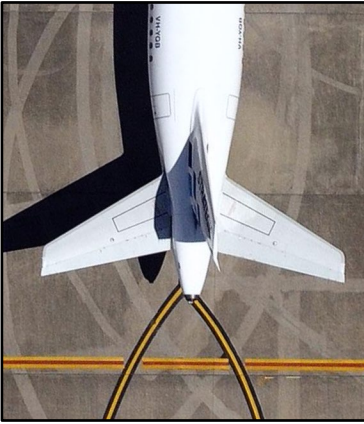

No vehicle is permitted to cross the Parking Clearance line without ATC permission at either the Domestic or International Terminals. The boundary is depicted in the images above.

Vehicles are to travel via the **Perimeter Road and the marked Apron roadways**, to the appropriate bay, then onto the apron.

**PENALTY: Using the Apron/Aircraft stands as a short cut may result in a 1 (one) month ADA suspension.**

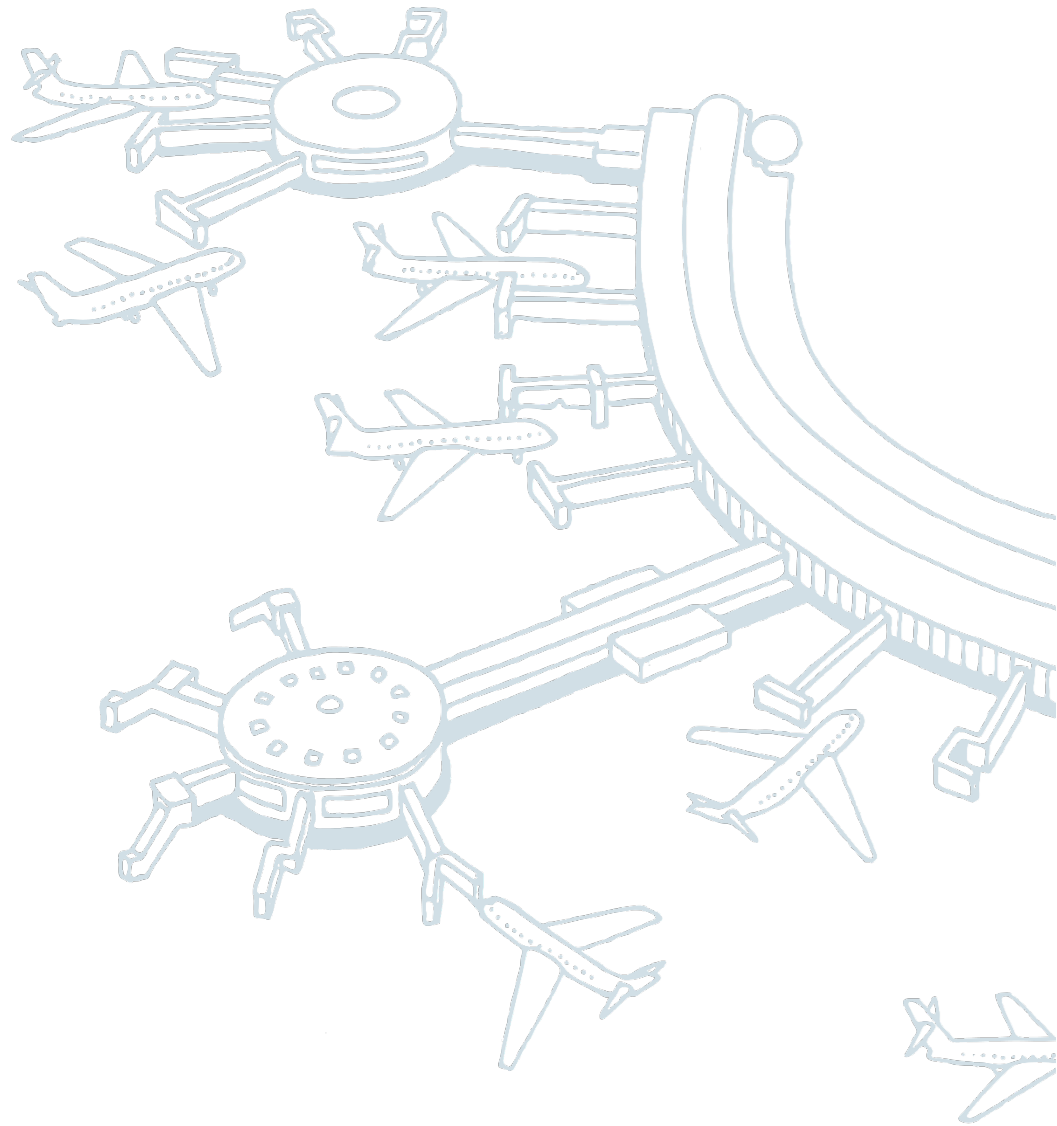

# CATEGORY 2A AUTHORITY TO DRIVE AIRSIDE

**Perimeter Roads** (Excluding Restricted Area accessed only by ARFF, BAC,AFP,ABF,ASA & approved contractors - refer Appendix B)

**Aircraft Stand & Apron Areas**

Applicants for Category 2A are required to read all of Category 1, 2 plus this entire following section

## 2.12 Apron Requirements

All drivers operating on the Manoeuvring Area are required to possess an Aeronautical Radio Operator Certificate (AROC) issued by CASA.

Drivers must not enter the Manoeuvring Area unless there is an operational requirement to do so and must have ATC prior approval. Unless you are towing an aircraft or relocating a pushback tug, the Perimeter Road is the safest route and must be used to circumvent the Runways and Taxiways (with the exception of the ARFF emergency requirements).

When two or more vehicles on the Manoeuvring Area are near each other, unless otherwise directed by ATC, the normal rules of the “State Road Laws” shall apply as for right hand drive vehicles (e.g. pass approaching vehicles keeping to your left of that vehicle).

All drivers must report to ATC immediately if it is suspected an item has been lost in transit.

Before learning radio procedures, it is necessary to fully understand and appreciate the regulations which apply to the Movement Area and specifically the Manoeuvring Area.

## 2.13 Vehicle Requirements

Radio Communications – Vehicles must be fitted with a reliable radio for communications with ATC.

Callsign – Vehicles accessing the Manoeuvring Area must be issued with a Callsign from BAC Airside Operations.

Vehicle Lighting - All vehicles operating on the Manoeuvring Area must be fitted with an amber rotating beacon or amber flashing light on the highest part of the vehicle to provide 360 degrees visibility unless accompanied by another vehicle so equipped.

Transponder - Taxiway and runway only.

## 2.14 Advanced – Surface Movement Guidance Control System (A-SMGCS)

A vehicle locator transmitter or ‘Transponder’ capable of detection by the Advanced Surface Movement Guidance Control System (A-SMGCS) (See also CASR139.254 (3) (a) (i) must be fitted all vehicles. All vehicles accessing the Maneuvering Area must comply.

ATC monitor vehicle movements on the Maneuvering Area via A-SMGCS. In the event of a Transponder failure, ATC will notify the vehicle operator and the Airside Safety Officer via the radio. The vehicle must then exit the Maneuvering Area via the nearest available exit point. Should the vehicle have an aircraft under tow, the vehicle will be permitted to complete the tow.

Where a vehicle operator has been notified of an inoperable Transponder, the vehicle must not return to the Maneuvering Area until it is equipped with a serviceable Transponder.

Hexadecimal codes are issued by Airside Operations. Refer to request for transponder code.

## 2.15 Radio Procedures

Only vehicles with prior BAC Airside Operations approval, and equipped with a radio capable of two way communication with ATC, are permitted to operate on the Manoeuvring Areas.

Non-radio equipped vehicles may however be escorted by an appropriate radio equipped vehicle and qualified driver.

Radio procedures for aircraft radiotelephone are not the responsibility of BAC.

A Category 2A candidate requires possession of an Aeronautical Radio Operator Certificate (AROC) as issued by CASA.



Example of when first contacting ATC:

- WHO:** GROUND, Tug Fifty Two
- WHERE:** At Bay 80
- WHAT:** Request approval tow aircraft to Bay 75

## 2.15.1 Radio Transceiver Failure

If radio communications are lost during pushbacks or relocations within the Apron Taxilane system, the driver should immediately recheck their transceiver settings and observe the Control Tower for signalling.

If no signals are apparent, the driver should, with due care and attention, vacate the Manoeuvring Area without attempting further transiting, checking for Control Tower signals at all times until radio communications can be re-established.

## 2.15.2 Radio Frequencies

TABLE OF FREQUENCIES	
Ground (SMC North)	124.05
Ground (SMC Domestic)	121.70
Ground (SMC South)	122.25
Aerodrome Terminal Information Service (ATIS)	125.50

Radio contact with the appropriate Ground Frequency is necessary if you intend to proceed from the Aircraft Stand onto the Apron Taxilane.

ATC will advise when pushback may be undertaken, traffic on the Apron, if any, and other relevant instructions as necessary.

There are three ground radio frequencies (Surface Movement Control) at Brisbane Airport.

The SMC frequency split locations as per figure 57 next page.

Figure 56 Example of Ground Frequency Change MAG Sign

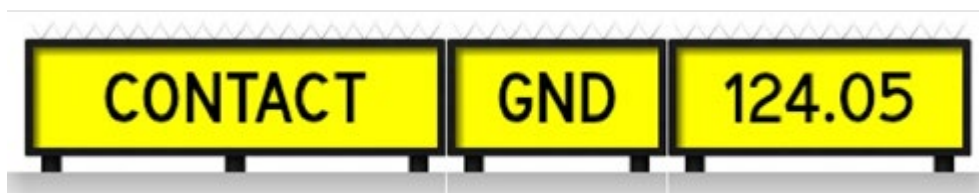

The MAG sign in Figure 56 above is an example of the frequency change MAG sign located on TWY Charlie, North of TWY Charlie 1.

Figure 57 SMC Radio Frequency Split Map

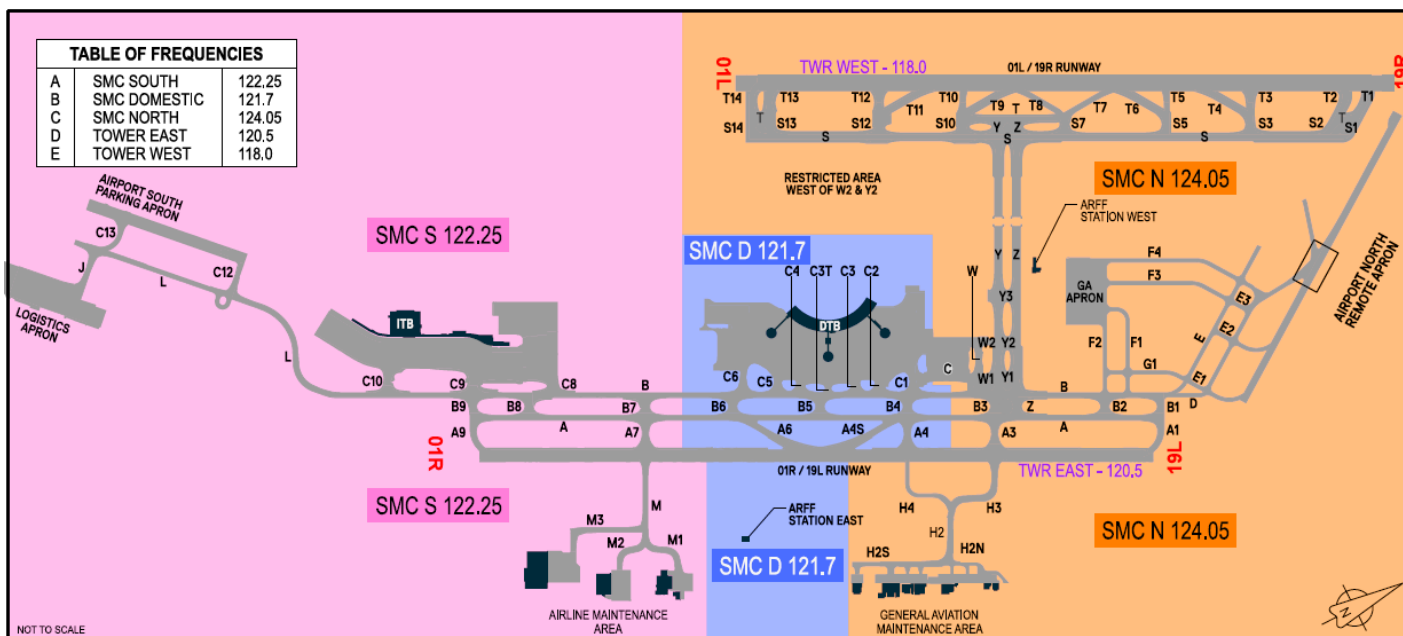

The radio frequency switch applies to all traffic, vehicles, tugs, aircraft operating on the movement area.

The frequencies are (as per figure 57) SMC D (Domestic) 121.70, SMC S (South) 122.25 & SMC N (North) 124.05.

On first contact with BNE Ground (depending on your location),

- ITB Apron, Logistics Apron & Airline Maintenance Area – contact **SMC S** 122.25MHz,
- DTB – contact **SMC D** 121.70MHz
- GA, General Aviation Maintenance Area & Bays 100-111 – contact **SMC N** 124.05MHz.

If you get lost or are unsure of what frequency you should be on and have not already entered the movement area, remain clear and when able contact SMC on what you think maybe the correct frequency and they will instruct you if you are to be on another frequency. If you are on the movement area comply with your last ATC instruction and when able contact ATC with your request for frequency check.

If in doubt, at all times comply with ATC instruction; they will; if needed, advise you when to change frequency.

If you are on a Perimeter Road wanting to enter a Taxiway, contact the relevant SMC frequency and they will issue the appropriate ATC clearance.

### 2.15.3 Radio Read backs

A full read back is required for all instructions by ATC. Read back any clearance or instruction:

- From Ground or Tower Frequency;
- Pushback - tail south;
- Hold short of a runway;
- Enter a runway;
- Cross a runway; or
- Travel via a specified route (include the runway designator at all times).

If unfamiliar with the layout of the airport, ask ATC for detailed instructions. When you are instructed to monitor a frequency, you should listen without initiating contact.

Clarify any misunderstanding or confusion concerning ATC instructions or clearances. For example, over transmitting may lead to confusion and lack of clarity in the instruction or read back. Seek clarification immediately.

## 2.15.4 Maintaining a Listening Watch on Movement Areas

Once you are physically inside the Movement Area, which includes:

- On any Taxiway/Taxi lane; or
- On the Runway; or
- Inside the Runway Strips; or
- Inside the Taxiway strips (unmarked and 95m wide),

**You are required to maintain a LISTENING WATCH on the appropriate frequency.**

All other communications systems such as mobile phones and other transceivers must not interfere with your Aeronautical Transceiver (know the actions to be taken if your communications with ATC have failed).

You should always be within hearing distance of the ATC frequency. Often, a change in wind directions or other operational factor may require ATC to re-direct you along an alternate route.

## 2.16 Phraseology

Drivers must use ICAO standard words and phrases for efficient two-way radio communication.



Phraseology commonly used in aerodrome surface operations.

<b>ACKNOWLEDGE</b>	Let me know that you have received my message.
<b>AFFIRMATIVE</b>	Yes.
<b>APPROVED</b>	Permission for proposed action granted.
<b>BREAK BREAK</b>	A term used to indicate the separation between portions two messages. (To be used when there is no clear distinction between the text and other portions of the message).
<b>CANCEL</b>	Cancel the previously transmitted clearance.
<b>CONFIRM</b>	Have I correctly received the following..? Or did you correctly receive this message.
<b>CONTACT</b>	Establish radio contact with.....
<b>CORRECTION</b>	An error has been made in this transmission (or message indicated) the correct version is...
<b>CLEARED</b>	Authorised to proceed under the conditions specified.
<b>CROSS RUNWAY</b>	An instruction from Ground to cross the Runway
<b>DISREGARD</b>	Consider that transmission not sent.
<b>EXPEDITE</b>	Travel safely as quickly as possible
<b>FINAL</b>	Commonly used to mean that an aircraft is on the final approach course or is aligned with a landing area.
<b>HOLD POSITION</b>	Stay in place; where you are currently located.
<b>HOLD SHORT OF</b>	Do not proceed past the HOLDING POSITION associated with the position given. This may be a Runway or Taxiway.



HOW DO YOU READ?	What is the readability of my transmission? Note: The readability scale is: 1. Unreadable 2. Readable now and then 3. Readable but with difficulty 4. Readable 5. Perfectly readable
I SAY AGAIN	I repeat for clarity or emphasis.
NEGATIVE	“No,” or “permission not granted,” or “that is not correct.”
LINE UP AND WAIT	Used by ATC to inform a pilot to taxi onto the departure runway and to hold in take-off position. <i>It is not an authorisation for take-off.</i> It is used when take-off clearance cannot immediately be issued because of traffic or other reasons.
READ BACK	Repeat all, or the specified, of this message back to me exactly as received.
ROGER	I have received all of your last transmission. <i>Under no circumstances to be used in reply to a question requiring READ BACK or a direct answer in the affirmative or negative.</i>
SAY AGAIN	Repeat all or the following part of your last transmission.
SPEAK SLOWER	Reduce your rate of speech.
STAND BY	Wait and I will call you. Means the controller or pilot must pause for a few seconds, usually to attend to other duties of a higher priority. The caller should re-establish contact if a delay is lengthy. “Stand by” is not an approval or denial.
UNABLE TO COMPLY	Indicates inability to comply with a specific instruction, request, or clearance.
VERIFY	Request a check and confirmation of the information identified (for example, “verify squawk code”).
WILCO	I understand your message, and will comply with it.

The use of words ‘GO AHEAD’ is not considered standard phraseology due to the possibility of misinterpreting ‘GO AHEAD’ as an authorisation to proceed with the intended request.

## 2.17 Apron Lighting and Pavement Markings

Apron Lighting	
Edge	Blue Apron Edge Light - Blue 
Apron Pavement Markings	
Apron Taxi Guidance Markings	Single Yellow Continuous 
Push Back Markings	Single White Broken 

## 2.18 Towing Aircraft

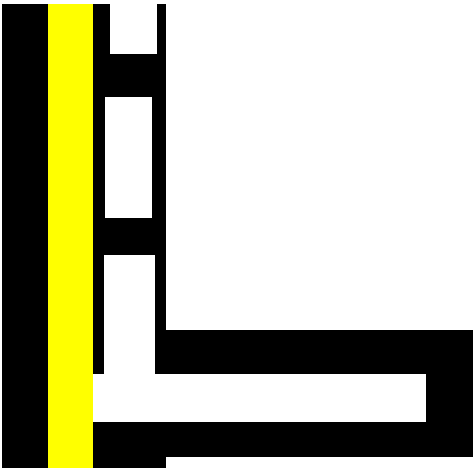
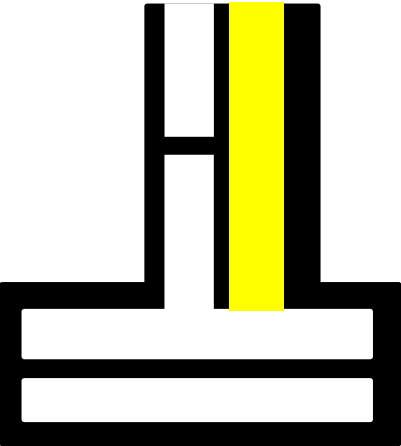
Apron Pavement Markings	
Parking Clearance Line	
Apron Edge	Double Yellow Continuous 
Tug Disconnect Point	Single White Line perpendicular to the centreline 
<p>A tug disconnect point is a specific location on the Movement Area that aircraft are pushed back to. They enable aircraft to be pushed back and held clear of other parked or taxiing aircraft.</p> <p>The International Apron has pushback to position points C through to H. Refer to Figure 58 on the next page for example.</p>	
Pushback Limit Marking	Pushback Limit markings indicate the furthest point at which the nose wheel of the aircraft is permitted to travel, before proceeding to the disconnect point or proceeding with tow relocation. 
<p>Refer to Figure 59 below for example.</p>	

Civil Aviation Regulation (CAR) 196 (3) states that "Unless CASA otherwise directs, an aeroplane in flight or operating on the manoeuvring area of a land aerodrome shall display, in addition to the navigation lights, an anti-collision light consisting of a flashing red light visible in all directions...."

An aircraft under tow is considered to be operating. From above navigation lights and the red rotating beacon must be on when on the taxiways and runways. If this is not achievable then a vehicle must be in company following the "dead or cold" aircraft to ensure an aircraft or vehicle following has visibility of what is directly in-front of them.

When repositioning aircraft, standard push back lines shall be used. Failure to carry out standard push backs can impact apron traffic. Requests shall be prefixed with the phrase "non-standard push back.....". Request should include information such as "we will push back the whole way" or "require to disconnect tug and turn around prior to tow".

Figure 58 Tug Disconnect Point Example



Figure 59 Pushback Limit Marking Example

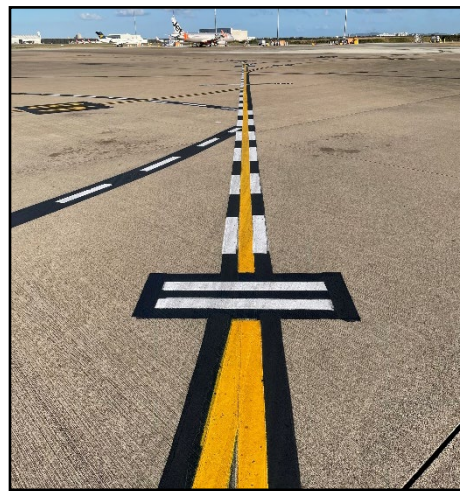

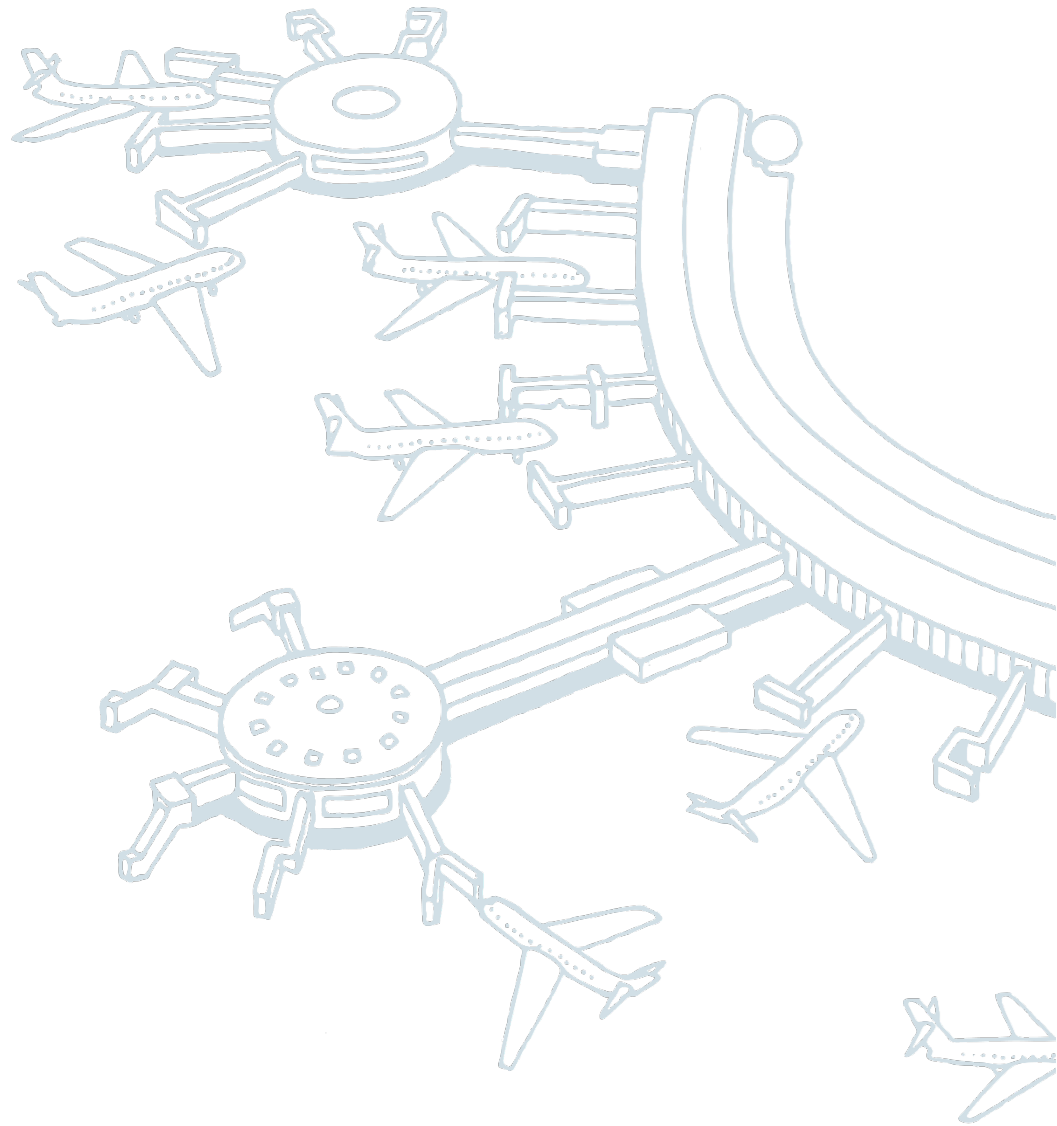

# CATEGORY 3 AUTHORITY TO DRIVE AIRSIDE

**Perimeter Roads** (Excluding Restricted Area accessed only by ARFF, BAC,AFP,ABF,ASA & approved contractors - refer Appendix B)

**Apron and Taxiways** (Excluding Restricted Area accessed only by BAC & ARFF personnel)

Applicants for Category 3 are required to read from Category 1 through to and including this entire section.

# 3. TAXIWAY REQUIREMENTS

You will need to know the designations and directional (aircraft) flow of **ALL** the Runways and Taxiways (excluding the Restricted area – BAC & ARFF only) so that you can advise ATC of your whereabouts at any time.

It is important to be aware of the taxiway (aircraft) directional flow when preparing to drive on the taxiway system. Directional flow will be dependent on the Runways in use and or ATC requirements. For Taxiway directional flow maps please refer Appendix C.

The instruction given by ATC will vary from time to time depending upon Airside works or aircraft traffic at the time. Instructions to travel via the taxiway system may vary to best facilitate usage of the taxiway system for ALL users.

Ensure to maintain a thorough knowledge of the taxiway system.

**Please note - the taxiway & runway system West of Taxiway W2 & Y2 is restricted to authorised vehicles only. Refer Airside Drivers Map, Appendix B.**

## 3.1 Radio Frequencies

Before requesting permission from Ground Frequency, all drivers must listen to the Aerodrome Terminal Information Service (ATIS) for information on possible Taxiway closures and other pertinent information (with the exception of the ARFF emergency requirements).

Radio contact with the appropriate Ground Frequency is necessary if you intend to proceed from the Aircraft Stand onto the Taxiways or Taxilane.

GROUND & ATIS FREQUENCIES	
Ground (SMC North)	124.05
Ground (SMC Domestic)	121.70
Ground (SMC South)	122.25
Aerodrome Terminal Information Service (ATIS)	125.50



Figure 60 SMC Radio Frequency Split Map

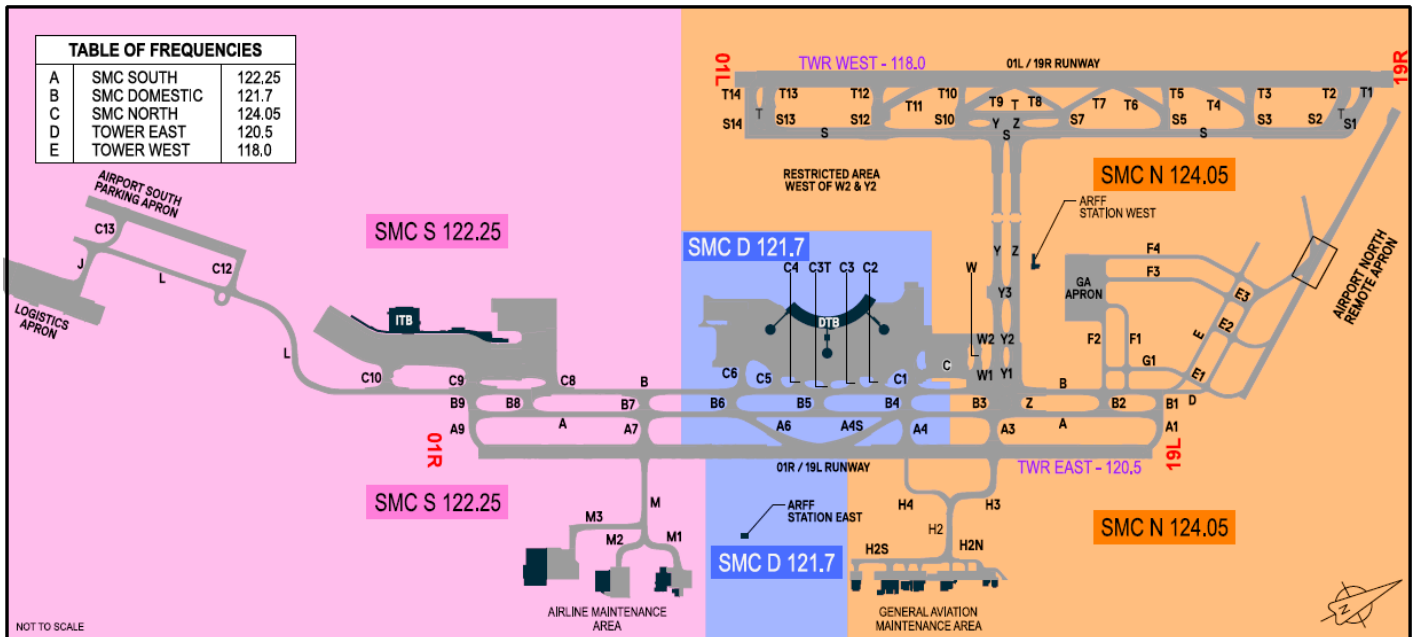

On first contact with BNE Ground,

- Everything south of the dividing line (B6 & B7) is SMC S on 122.25 (including the Taxiway M airline maintenance hangars),
- Everything between the dividing lines (B6 & B7 and B3 & B4) is SMC D on 121.70
- Everything North of the dividing line (B3 & B4) is SMC N on 124.05 (including the General Maintenance hangars).

Ground frequency MAG signs are located (between B6 & B7 and between B3 & B4) on Taxiways Alpha and Bravo advising of when to change frequency and which frequency to change to. Once you have passed the MAG sign contact that frequency when you are able, to advise of your call sign and your last ATC instruction received.

Figure 61 Example of Ground Frequency Change MAG Sign



### 3.1.1 Radio Transceiver Failure

If radio communications are lost during approach to a Runway crossing or during normal surface movement within the Taxiway system, the driver should immediately recheck their transceiver settings and observe the Control Tower for signalling.

Flashing Runway or Taxiway lights may indicate that radio problems exist, check the radio, vacate the Manoeuvring Area and look for light signals from the ATC Tower.

If no signals are apparent, the Driver should, with due care and attention, vacate the Manoeuvring Area without attempting a Runway crossing, checking for Control Tower signals at all times until radio communications can be re-established.

## 3.1.2 ATC Light Signals

If a driver receives light signals from the Control Tower, that driver must respond to them promptly.

The key points are:

- They are used when radio communications have broken down;
- They emanate from inside the Control Tower cabin, not on top, which is the rotating beacon;
- The signals are activated by the ATC personnel in the Tower; and

The signals have a very narrow beam. If you see it, it's meant for **YOU**.

The signals are seldom used, usually with the loss of communications or an emergency situation.

The signals are:

<b>GREEN FLASHES</b>	Permission to cross Runway or to move onto a Taxiway.
<b>STEADY RED</b>	Stop immediately.
<b>RED FLASHES</b>	Move off the runway or taxiway and watch out for aircraft.
<b>WHITE FLASHES</b>	Vacate the Manoeuvring Area in accordance with local instructions.
<b>Note:</b>	<i>In emergency conditions or if the signals are not observed, the following meaning will be indicated by lighting</i>
<b>Flashing Runway or Taxiway Lighting</b>	Vacate the manoeuvring area and observe the Control Tower for light signal.

All vehicles operating on the Manoeuvring Area must have the standard Control Tower signals label affixed ensuring it is clearly visible to the driver. (Available from the Airport Service Centre)





A vehicle driver in doubt as to the position of the vehicle with respect to the Manoeuvring Area shall immediately:

1. Notify Air Traffic Control (Ground or Tower) of the circumstances (including the last known position);
2. Simultaneously, unless otherwise instructed by the Air Traffic Control (Ground or Tower), vacate the landing area, Taxiway, or other part of the Manoeuvring Area, to a safe distance as expeditiously as possible; and then,
3. Stop the vehicle.

All vehicles operating on the Manoeuvring Area must have the Runway/Taxiway Identification sticker affixed ensuring it is clearly visible to the driver. (Available from the BAC ADA/AUA office)

## 3.2 Lighting and Pavement Markings

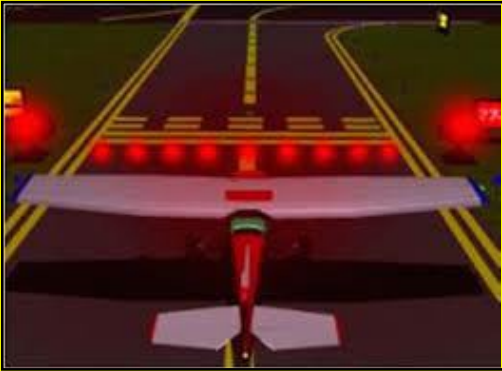
### 3.2.1 Runway Lighting and Pavement Markings

Runway Lighting	
<b>Centreline</b>	White
<b>Edges</b>	White Note: 01R / 19L Runway edge lights are Omnidirectional 01L / 19R Runway edge lights are Bi-Directional
<b>Start</b>	Green
<b>End</b>	Red
<b>900 metres from the end</b>	Red and white
<b>RWY Holding Position</b>	Three yellow 
<b>RWY Guard Lights</b>	 <p>2 flashing yellow lights on each side of the Taxiway (known as Runway Guard Lights)</p>
<b>Stop Bars</b>	 <p>Stop bars are a series of unidirectional lights at right angles to the taxiway centreline. The lights are spaced 3 meters apart and located 0.3m before the point at which it is intended the traffic approaching the runway must stop. Stop bars show red in the direction of approach to the stop bar from the taxiway</p>
Runway Pavement Markings	
<b>Centreline</b>	Single white broken
<b>Touch Down Zone</b>	Six white - either side of the Runway at each end
<b>Edges</b>	Single white Continuous
<b>Hold Point</b>	Double yellow continuous with double yellow broken
	

### 3.2.2 Taxiway Lighting and Pavement Markings



Taxiway Lighting	
Centreline	Green
Apron Edge	Blue (if the centreline lighting is unserviceable, blue lights may be deployed either side of the Taxiway)
Intermediate Holding Position	
Taxiway Pavement Markings	
Centreline	Single continuous yellow
Edges	Double continuous yellow
Apron Edge	Double continuous yellow
Intermediate Holding Position	

Figure 62 Intermediate Holding Point



The Intermediate Holding Points are located mid-way between the Rapid Exit Taxiways.

### 3.3 Runway Strip

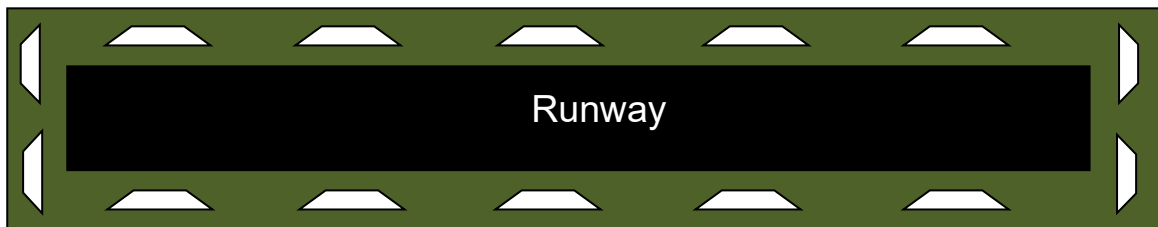

When crossing the Runway -

White gable markers mark the boundary of the Runway strip. Vehicles are not permitted to CROSS the Runway strip (proceed beyond hold point) without the specific prior approval from GROUND frequency quoting the word CROSS e.g., “Tug xx CROSS runway 19L”.

When entering the Runway, MEANS STAYING ON THE RUNWAY

White gable markers mark the boundary of the Runway strip. Vehicles are not permitted to enter the Runway strip (proceed beyond hold point) without the specific prior approval from TOWER frequency quoting the word ENTER e.g. "Car 13 ENTER runway 19L".

### 3.4 Stop Bar Procedures

Stop Bar Definition:

Runway Stop Bars are a series of inset & elevated red lights which are located at all runway holding points. Drivers must not cross the Stop Bars while they are illuminated and without ATC clearance.

**Note: Stop Bars to be crossed by Category 3 RWY Drivers ONLY.**

### 3.5 Movement Area Guidance Signs (MAGS)

Brisbane Airport has an extensive system of Movement Area Guidance (MAG) signs throughout the Manoeuvring Area. Drivers authorised to drive on the Manoeuvring Area (Category 3 and 3 RWY ADA) must be familiar with these signs.

Figure 63 Runway Designation Sign



The photograph in figure 63 above depicts the Runway 19L end of the main Runway. **A1** indicates Taxiway A1 (yellow writing with a black background). The **19L** indicates the commencement of Runway 19L (white writing with a red background). Any MAG Sign with white writing and a red background, means do not proceed past this point without approval from ATC.

All drivers must stop at the Runway designation signs and seek clearance from Ground Frequency to cross the Runway. Drivers are not permitted, under any circumstances, to cross any Runway until the Ground Frequency has granted approval to "CROSS" the designated Runway.

Figure 64 Direction Signage



As an example, the yellow writing with a black background indicates that you are on Taxiway S1 (Sierra 1). The black writing with a yellow background with the arrows indicates, if you were to head in that direction it would take you to the corresponding Taxiway. For example, if I were to head left from Taxiway Sierra 1, I would be travelling onto Taxiway Tango.

**Figure 65** Aircraft "No Entry" Sign



The photograph depicts a NO ENTRY sign, consisting of a white circle with a horizontal bar in the middle, on a red background. NO ENTRY Sign identifies where aircraft and vehicles are prohibited from entering, unless specifically instructed to by ATC.

### 3.6 Logistic Turning Loop

Figure 66 Logistics Apron & Taxiway Lima – Turn Around Loop

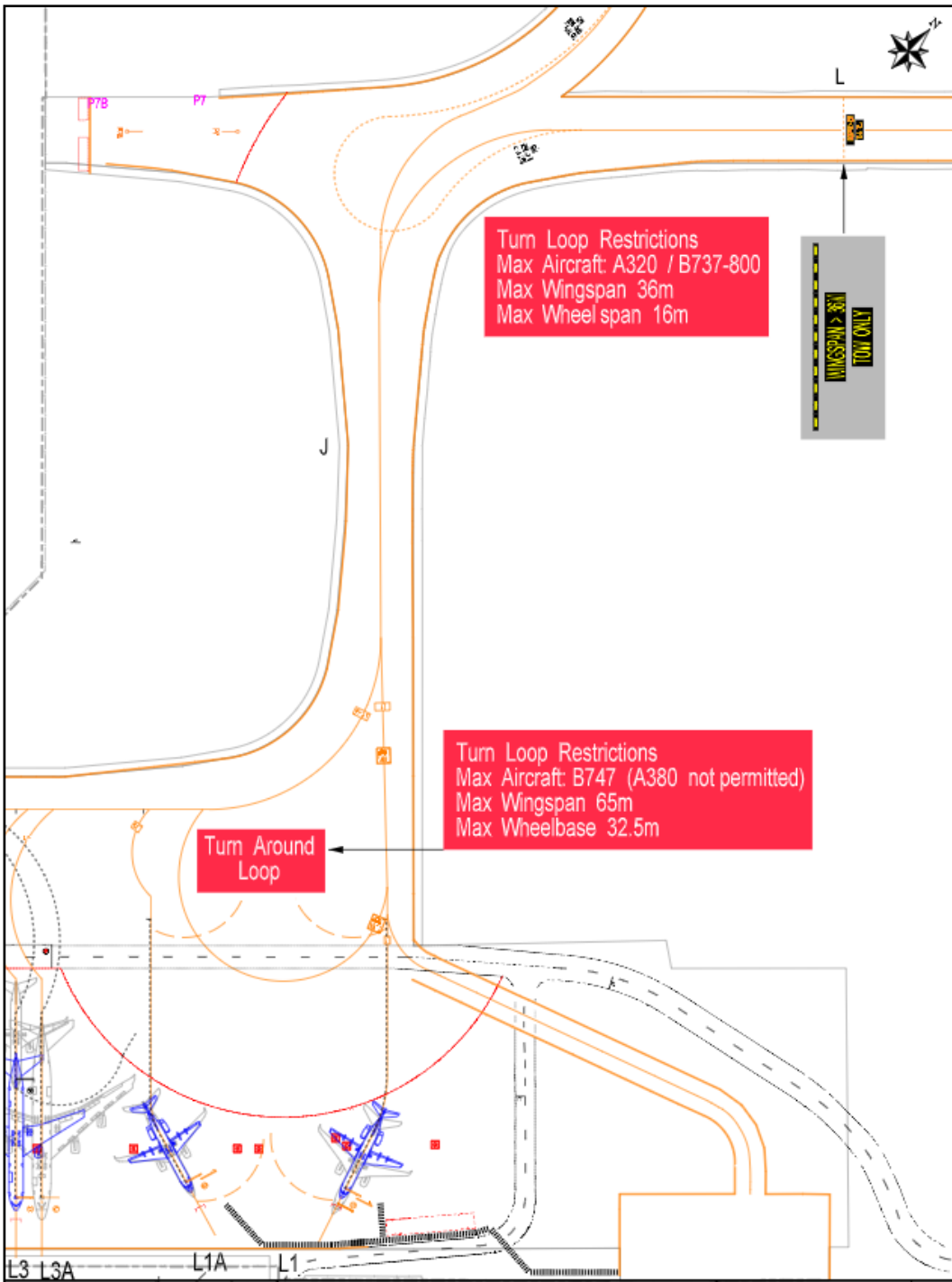

Figure 66 above lists the only aircraft under tow that are permitted turn from TWY C13 onto TWY L at TWY J or TWY L on to TWY C13 at TWY J due to no fillet pavement. All other aircraft must use the turnaround loop available for aircraft up to and including B747 on the Logistics Apron.

## 3.7 Logistics Apron – Widebody Aircraft (wingspan >36m)

All aircraft with a wingspan greater than 36m, must be under tow only to access the Logistics Apron for arriving aircraft. These aircraft must stop and be towed from the intermediate holding point just north of TWY C13. For departing aircraft with a wingspan greater than 36m, aircraft must be towed to the intermediate holding point just south of TWY C12 for departure.

## 3.8 Some General Tips

Before you go out onto the Movement Area:

- Ensure vehicle is fully operational, fuelled, loads covered;
- Check spare tyre for inflation & condition;
- Constantly use your Omni vision;
- Watch for aircraft (360 degrees);
- FOD check - ensure no articles inside or outside a vehicle can become airborne, or fall out on opening a door;
- Know the procedures;
- Know the light signals;
- Be precise – and patient;
- Comply with this Handbook;
- Keep your eyes open, stay alert and never go beyond hearing range of your radio;
- Plan work carefully and avoid any tendency to rush whilst Airside. Do it right, do it once; and
- Never leave anything (equipment or tools) on the Movement Area (includes Runway and Taxiway strips).



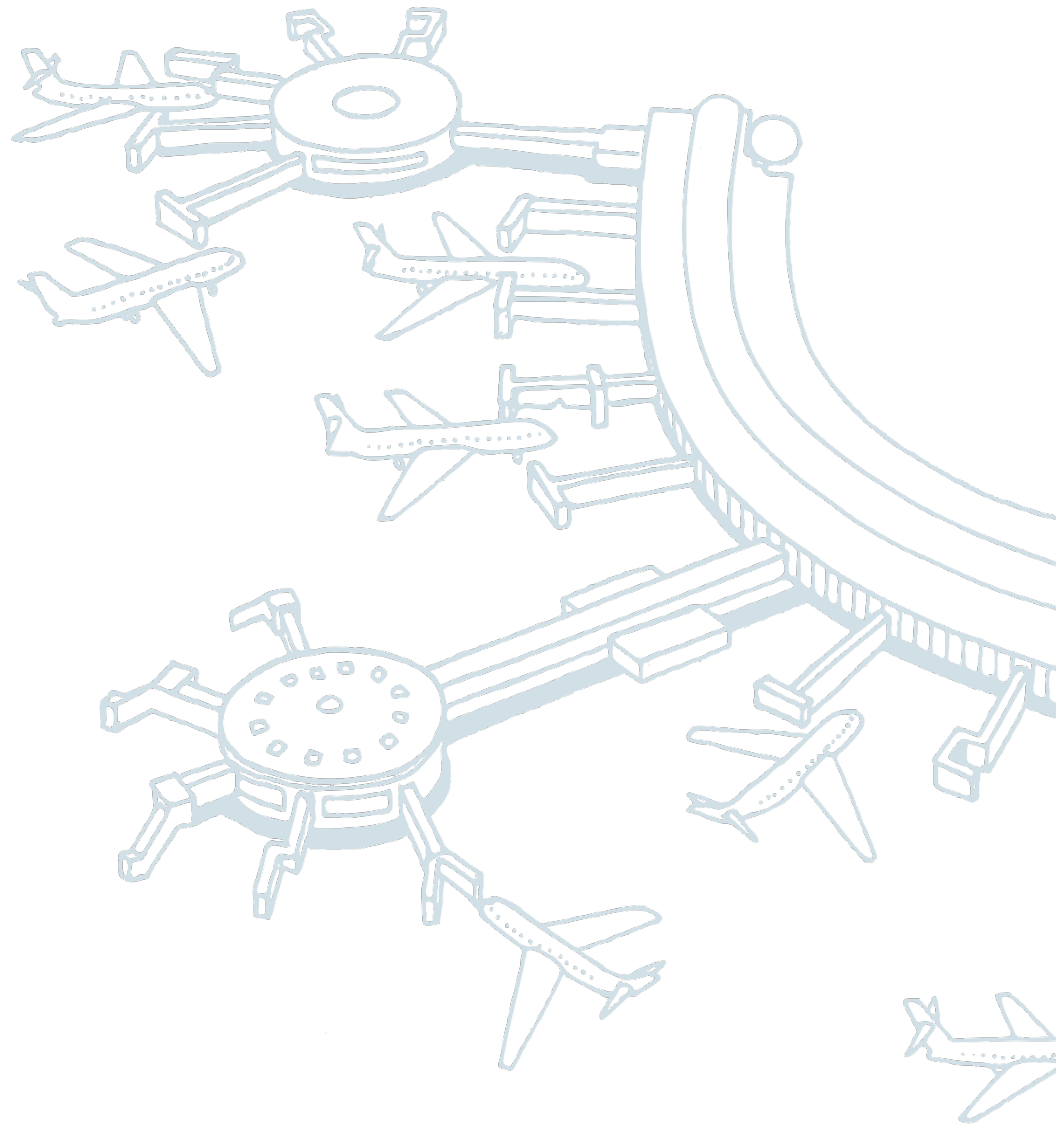

# CATEGORY 3 RUNWAY

Authority to Drive Airside

**All Movement Areas** (Excluding Restricted Area accessed only by BAC & ARFF personnel – refer Appendix B)

Applicants for Category 3 Runway are required to read the entire Handbook

## 3.9 Radio Frequencies

Before requesting permission from Ground Frequency, all drivers must listen to the Aerodrome Terminal Information Service (ATIS) for information on possible Taxiway closures and other pertinent information (with the exception of the ARFF emergency requirements).

Radio contact with Ground Frequency is necessary if you intend to proceed from the Aircraft Stand onto Taxiways, Crossing or entering a Runway;

TABLE OF FREQUENCIES	
Ground (SMC North)	124.05
Ground (SMC Domestic)	121.70
Ground (SMC South)	122.25
Tower West (RWY 01L/19R)	118.00
Tower East (RWY 01R/19L)	120.50
Aerodrome Terminal Information Service (ATIS)	125.50

### 3.9.1 Procedure

Consideration must be given to ATC workloads in peak hour Runway movement conditions in requests for Runway crossings.

Approved Vehicles seeking to cross the Runway must comply with the following:

- Be under the control of a Category 3 – RWY ADA holder;
- All open vehicles must have head phones fitted for contact with ATC;
- Even when cleared to cross, Drivers **must** conduct visual checks for aircraft on or approaching the Runway before crossing;
- Never change frequency until you are directed to do so;
- All persons, including Drivers of vehicles required to hold short of a Runway, must hold at the appropriate holding point for that Runway, or the runway strip edge (the line of gable markers);
- Airside Drivers must, whilst waiting to cross:
  - Remain outside the Runway Hold Point;
  - Observe for all aircraft on or approaching the Runway;
- Be prepared to relocate to another Taxiway in case a landing aircraft requires to vacate the Runway via the Taxiway where the Driver is located;
- Be capable of describing their exact location at any time (e.g. on Taxiway B between B6 and B7).
- Before transmitting on ATC frequencies, make sure the channel is clear.
- The instruction to access or cross the Runway will be given by ATC on Ground frequency.
- Use standard words and phrases for efficient two-way radio communication.
- Read back the instructions exactly as you receive them to ensure that you have understood the ATC clearance/instruction.
- Prior to crossing the holding point, check the Runway for aircraft departing or arriving.
- If unsure about any other traffic on the Runway, do not move and ask GROUND about the traffic.

- Only GROUND can authorise YOUR runway crossing, must contain **BOTH** your **CALLSIGN** and words “**CROSS RUNWAY**”.
- After fully vacating the Runway contact GROUND and advise when vacated.

**Never cross an illuminated Stop Bar.**

**Remember another vehicle or aircraft could be waiting to cross the runway elsewhere.**

### 3.10 Runway Crossings Requirements

It is fundamental to aerodrome safety that all Vehicle Operators and personnel using the manoeuvring areas are fully conversant with current communication procedures, their application and safety basis. Crossing runways is a well identified safety risk requiring rigorous procedures and situational awareness by all concerned.

- Drivers must secure all loose items on vehicles so that these do not become potential FOD;
- All aircraft must be inspected for loose items, covers, prop straps, Pitot tube covers etc.;
- All Drivers are to have an understanding of the wind direction and the Runway in use;
- Tow bars must be checked for serviceability before towing aircraft.

Runway crossings are only to be undertaken within the following parameters:

	Hours	Towing an Aircraft	Not towing an Aircraft
Oversize Tugs (see definition below)	0000 - 2359	Yes	Yes
Other Tugs	0000 - 0430	Yes	Yes
	0430 - 2359	Yes	No

Definition of an oversized tug:

- Weight is in excess of 34 ton load limit for Boggy creek bridge; and
- Width is in excess of 2.6 meters.

Compliance

- ATC are not responsible for policing Runway crossings; their role is to facilitate safe separation of aircraft and vehicles;
- The restrictions implemented have been introduced due to runway demand for arriving and departing aircraft, ATC workload and to minimize the risk exposure of runway crossings;
- These restrictions will be monitored through the Airside Operations Centre Team; and
- A one (1) month suspension of ADA for drivers failing to comply with the above restrictions.

Refer Penalties Table (Appendix A) for reference to breaching the above parameters.

Vehicles are not permitted to follow Aircraft or Tugs across the Runway, and must use the Perimeter Road, except in the case of personnel attending aircraft engine ground runs when being undertaken on a Manoeuvring Area or following a “dead” or “cold” aircraft (with the exception of the ARFF emergency requirements). **All other traffic must use the Perimeter Road system.**

### 3.10.1 Stop Bar Procedures

Stop Bar operations are in place at all taxiway holding points for Runway 01R/19L and Runway 01L/19R

What is a Stop Bar?

- Stop Bars are a series of unidirectional lights at right angles to the taxiway centreline.
- The lights are spaced 3 meters apart and located 0.3m before the point at which it is intended the traffic approaching the runway must stop.
- Stop Bars show red in the direction of approach to the stop bar from the taxiway.
- Stop Bars at Brisbane Airport will also be complemented by existing yellow Runway Guard Lights, MAG Signs and Runway Holding Point markings.
- Stop Bars are in operation 24 hours, seven days a week and are controlled by Air Traffic Control (ATC).

Vehicle operators are required to stop at the Runway Holding Point/Stop Bar and obtain clearance from ATC prior to entering a runway.

#### ATC frequency requirements:

*For entry to RWY -ATC Tower (TWR)*

*For crossing the RWY -ATC Ground (SMC)*

Clearance to enter/cross the runway by ATC will be issued in the following sequence:

1. ATC will extinguish the red Stop Bar lights and:
2. Simultaneously issue the appropriate clearance.

Figure 67 Stop Bar Sequence

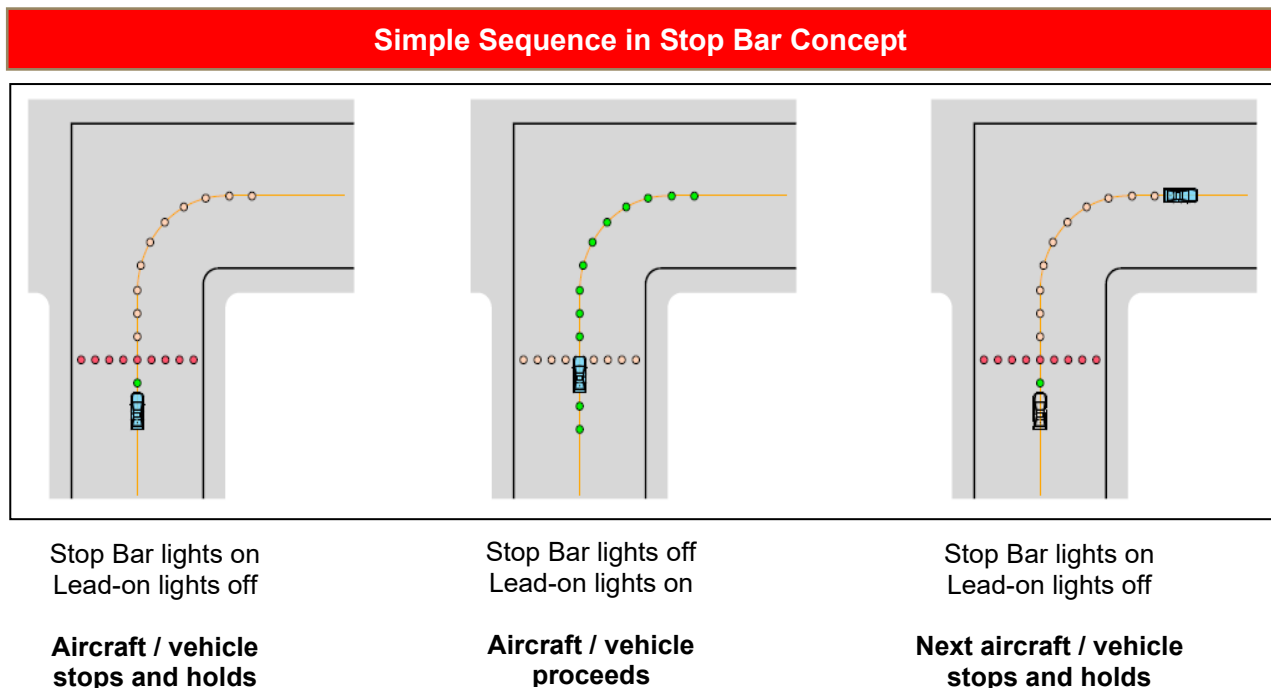

**STOP AT THE RED LIGHT!**

Drivers must comply with the following when stop bars are in operation:

- **Never cross an Illuminated Stop Bar**
- Only proceed past a Stop Bar when ATC provides the appropriate verbal instruction AND switches the Stop Bar lights off.

- If a driver is granted a verbal clearance to enter or cross a Runway and then proceeds across an illuminated Stop Bar, it will be treated as a Runway incursion resulting in immediate suspension of the drivers ADA.

**Recommended practice:**

- Check Stop Bars have been extinguished when reading back ATC clearance prior to entering the runway

**Note: Under normal operations when Stop Bars are extinguished, green lead on lights come on.**

Figure 68 Stop Bar Location Map

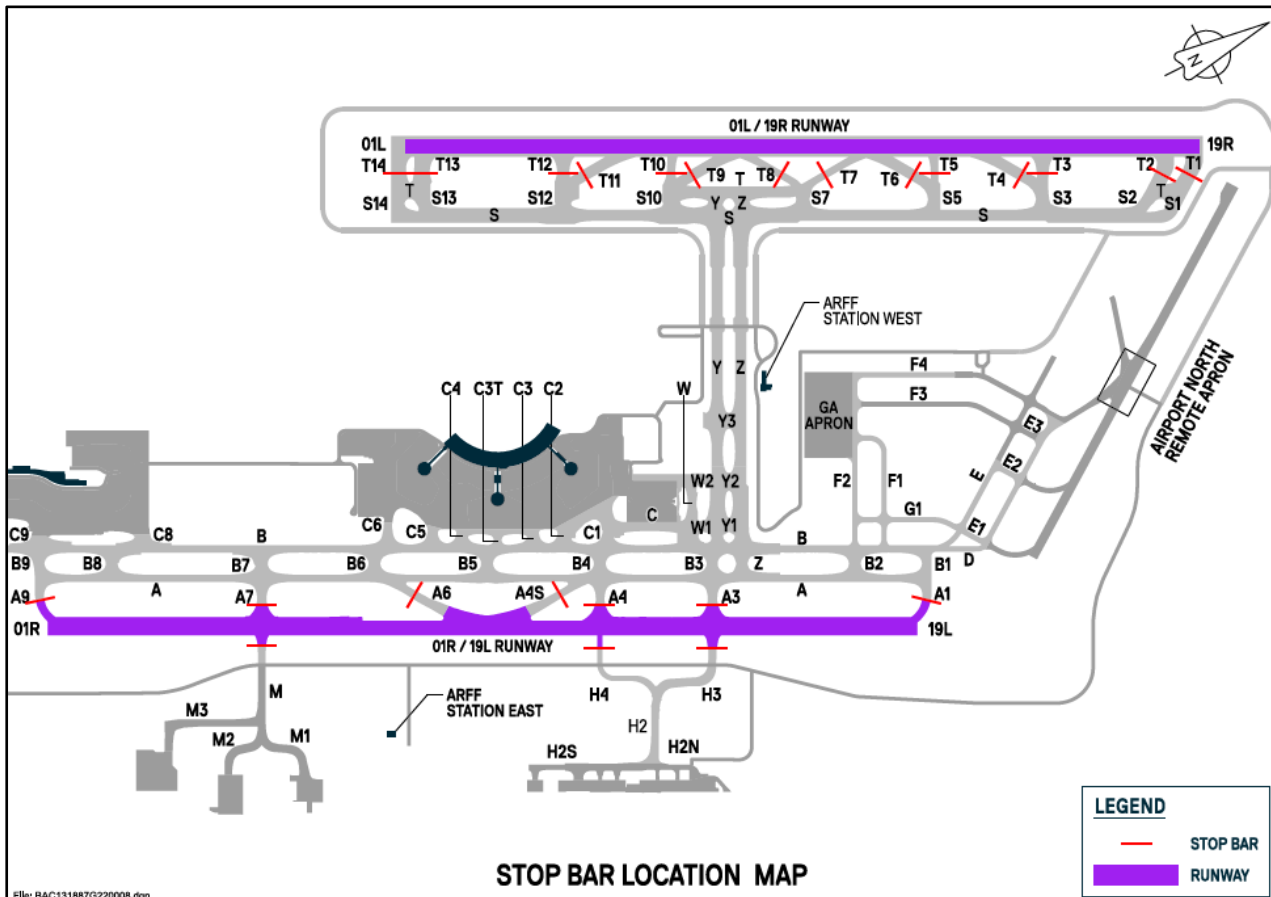

When a Category 3 RWY driver requires to cross or enter a runway, Stop Bar operations require the driver to stop and hold at an illuminated (RED) Stop Bar and to only proceed when:

- ATC gives the appropriate verbal instruction; and
- Switches off/extinguishes the stop bar for that taxiway holding point

Taxiway lead on lights will illuminate (GREEN) once the Stop Bar lights have been extinguished/turned off.

Note 1: In the event the stop bar does not switch off/extinguish, even if verbal permission was granted, the driver **MUST NOT CROSS THE STOP BAR and remind ATC to extinguish the Stop Bar.**

## Contingency Procedures

- In the event a fault occurs during Stop Bar switching, ATC has contingency procedures in place to ensure the safe movement of aircraft.
- If a Stop Bar switching fault occurs, ATC will **not** immediately implement contingency procedures.
- A minimum period of **15 minutes** will be allowed for corrective action to occur.
- If the Stop Bar switching is still faulty, ATC may implement contingency procedures to allow traffic to cross an illuminated Stop Bar.

ATC will apply the following procedures during Stop Bar contingency:

1. ATC will only issue clearances to cross an illuminated Stop Bar at holding points that are visible to the tower.
2. ATC will use a suitable alternative holding point with a serviceable or deactivated Stop Bar in preference to crossing an illuminated Stop Bar;
3. As far as practicable, ATC will avoid the simultaneous use of multiple holding points for departure;
4. ATC will **not** apply stop bar contingency procedures when the RVR is less than 550m.

When contingency procedures are in place and involves crossing an illuminated Stop Bar two critical items of information are required for drivers and pilots:

1. Advice that the Stop Bar switching is faulty and that contingency procedures are in operation:  
“**STOP BAR SWITCHING AT HOLDING POINT(S) (name of holding point(s) UNSERVICEABLE, STOP BAR CONTINGENCY PROCEDURES IN FORCE -may be delivered by the ATIS or direct transmission.**”
2. Specific phraseology to authorise crossing the illuminated stop bar:  
“**AT (holding point), CROSS THE ILLUMINATED STOP BAR, LINE UP (or CLEARED FOR TAKE-OFF or ENTER or CROSS) RUNWAY (number)**”.

**BOTH of these items are required before you can cross an illuminated Stop Bar.**



### 3.11.2 Scenario 2: Domestic Apron to Qantas Hangar 2

Figure 70 Domestic Apron to Qantas Hangar 2

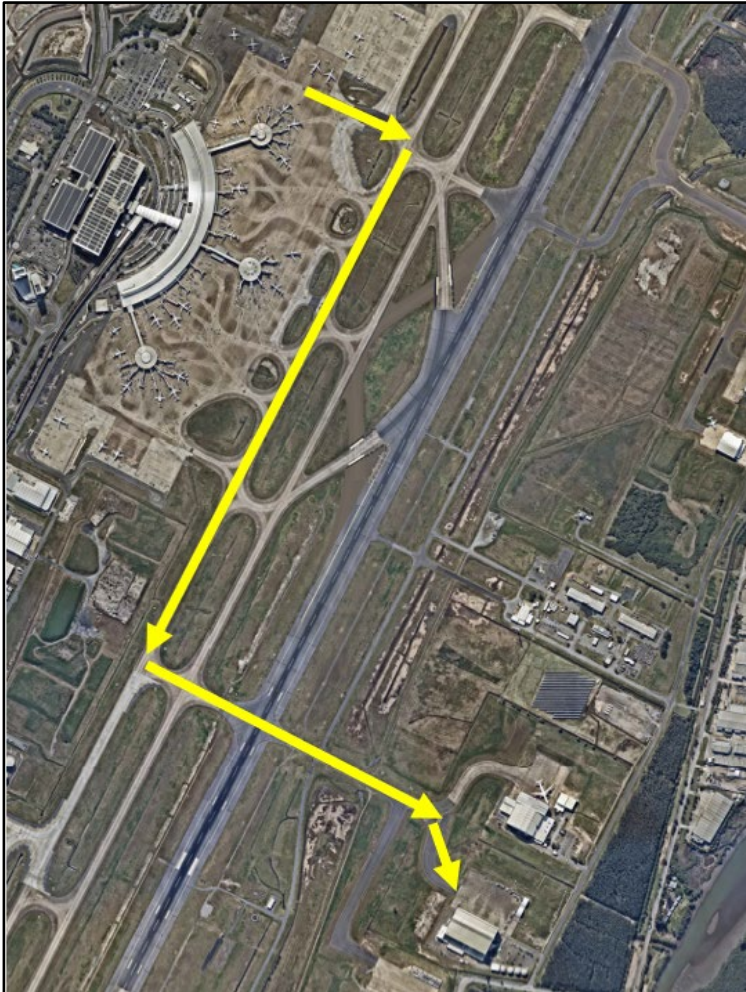

(RWY in use – 01R)

Driver: (121.7) "Brisbane Ground Tug 35 with Dash 8 under tow, at Bay 4 request tow to Hangar 2"

GROUND: "Tug 35 Brisbane Ground, tow approved via Charlie 1 and Bravo, at Alpha 7 HOLD SHORT of Runway 01R"

Driver: "Tow approved via Charlie 1, Bravo at Alpha 7 HOLD SHORT Runway 01R, Tug35"

Passing the MAG sign between Bravo 6 & Bravo 7, Tug driver switches frequency to SMC South 122.25

Driver: (122.25) "Ground, Tug 35 on Bravo, at Alpha 7 HOLD SHORT Runway 01R."

GROUND: Tug 35

Driver: "Ground, Tug 35 at Alpha 7 HOLDING SHORT Runway 01R"

GROUND: "Tug 35 at Alpha 7 CROSS Runway 01R, report vacated"

Driver: "At Alpha 7, CROSS Runway 01R, report vacated, Tug35"

Driver: "Ground Tug 35 vacated Runway 01R"

GROUND: "Tug 35 Ground proceed to Hangar 2"

Driver: "Proceed to Hangar 2 Tug 35"



### 3.11.3 Scenario 3: General Aviation Apron to Toll Hangar

Figure 71 General Aviation Apron to Toll Hangar



(RWY in use – 01R)

Driver: "Brisbane Ground Tug 42 at the General Aviation Apron 2 request clearance to Toll Hangar"

GROUND: "Tug 42 Brisbane Ground proceed Foxtrot 2, Bravo, Alpha 3 HOLD SHORT Runway 01R"

Driver: "Proceed Foxtrot 2, Bravo, Alpha 3 HOLD SHORT Runway 01R, Tug 42"

Driver: "Tug 42 at Alpha 3 HOLDING SHORT Runway 01R"

GROUND: "Tug 42 at Alpha 3 CROSS Runway 01R, report vacated"

Driver: "At Alpha 3 CROSS Runway 01R report vacated Tug 42"

Driver: "Ground, Tug 42 vacated Runway 01R"

GROUND: "Tug 42 Ground, proceed via Hotel 3 to Toll Hangar"

Driver: "Proceed via Hotel 3, to Toll Hangar Tug 42"

# APPENDIX A BAC PENALTIES TABLE

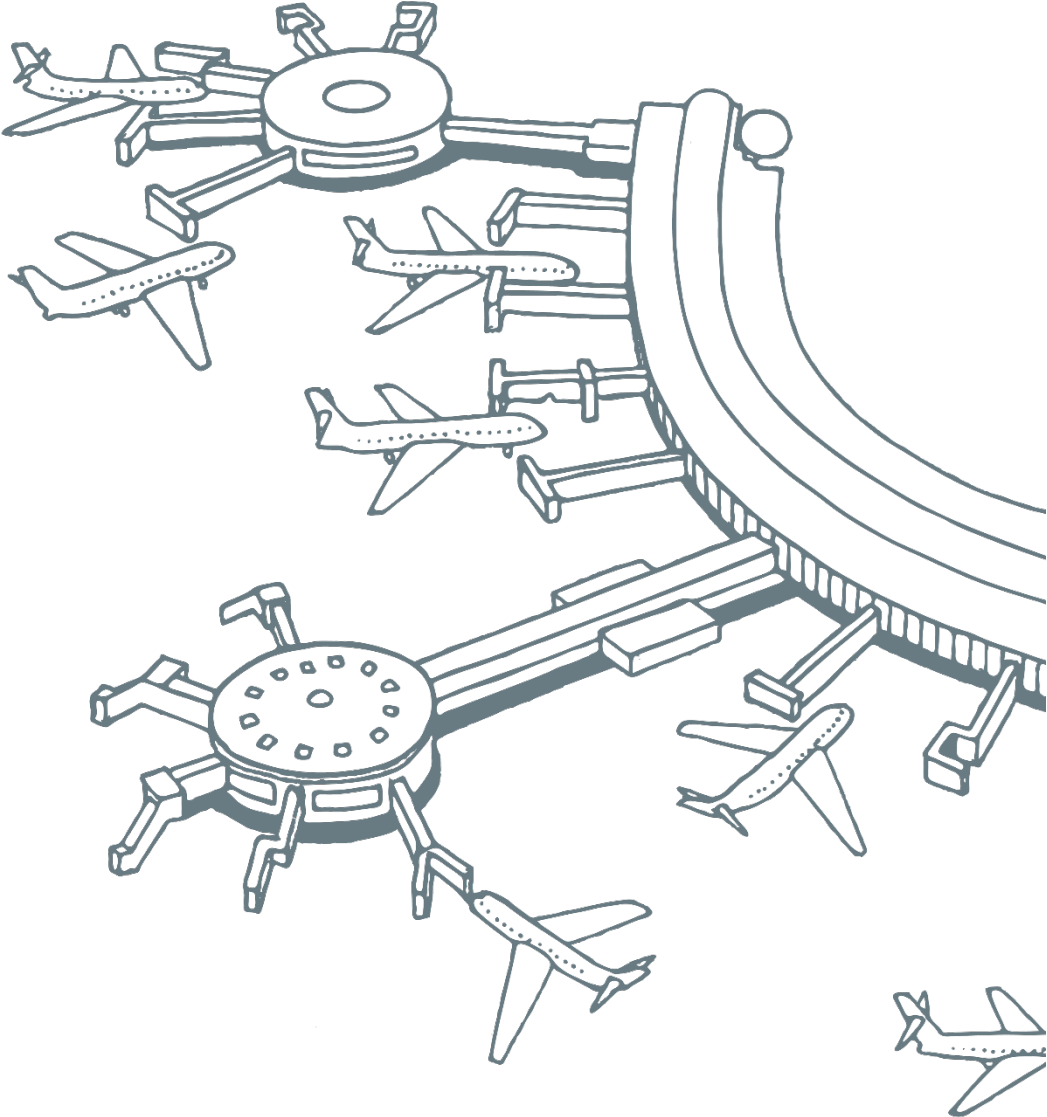

1. SPEEDING		
1.1	Exceeding the speed limit by less than 15km/h (except in Shared Zones)	Warning
1.2	Exceeding the speed limit by more than 15km/h but less than 30km/h (except in Shared Zones)	<b>1 month ADA suspension</b> and a loss of 4 penalty points
1.3	Exceeding the speed limit by more than 30km/h but less than 45km/h (except in Shared Zones)	<b>2 month ADA suspension</b> and a loss of 4 penalty points
1.4	Exceeding the speed limit by more than 45km/h (except in Shared Zones)	<b>4 months ADA suspension</b> and a loss of 4 penalty points
1.5	In a 20km/h Shared Zone – exceeding the speed limit by less than 10km/h	Warning
1.6	In a 20km/h Shared Zone – exceeding the speed limit by 10km/h or more	<b>1 month ADA suspension</b> and a loss of 6 penalty points
1.7	In a 20km/h Shared Zone – exceeding the speed limit by 30km/h or more	<b>2 month ADA suspension</b> and a loss of 6 penalty points
1.8	In 10km/h zone - exceeding speed by 5km/h to 10 km/h	A loss of 6 penalty points
1.9	In 10km/h zone - exceeding speed limit by 10 km/h or more	<b>1 month ADA suspension</b> and a loss of 6 penalty points
2. SAFETY IN THE VICINITY OF AIRCRAFT		
2.1	Failure to give way to taxiing aircraft	<b>6 month ADA suspension</b> and a loss of 10 penalty points
2.2	Failure to give way to aircraft under tow	<b>2 month ADA suspension</b> and a loss of 10 penalty points
2.3	Failure to give way to aircraft that has commenced push back	Loss of 10 penalty points
2.4	Driving within 3 metres of a parked aircraft	Loss of 3 penalty points
2.5	Using the Apron/Aircraft stands as a short cut	<b>1 month ADA suspension</b>
3. IMPROPER OVERTAKING		
3.1	Driving in a manner dangerous to other vehicles - Improper overtaking	<b>1 month ADA suspension</b> and a loss of 6 penalty points
4. DRIVING UNDER THE INFLUENCE		
4.1	Having returned a positive Drug or Alcohol test as per DAMP	Suspension of Authority to Drive Airside for Drivers operating under BAC's DAMP
5. COVER LOOSE MATERIAL		
5.1	Dropping rubbish/items/tools on the apron	Loss of 3 penalty points
5.2	Failure to remove loose/unused shrink wrap	Loss of 3 penalty points
5.3	Failure to stop and pick up FOD	Loss of 1 penalty point
6. TIMBER / PLASTIC PALLETS AIRSIDE		
6.1	Failure to remove timber / plastic pallets from the airside	Loss of 3 penalty points
7. IMPROPER PARKING		
7.1	Parking in a no parking zone	Loss of 6 penalty point
7.2	Parking/driving in a safety area under Aerobridges	Loss of 6 penalty points
7.3	Parking in an area that obstructs an emergency exit	<b>1 month ADA suspension</b> and a loss of 4 penalty points
7.4	Parking in an area that obstructs traffic	Loss of 3 penalty points

7.5	Parking in an area that obstructs pedestrians	Loss of 4 penalty points
7.6	Parking in an area that obstructs aircraft	Loss of 8 penalty points
7.7	Failure to park equipment correctly in an equipment staging or storage area	Loss of 3 penalty points
<b>8. SMOKING</b>		
8.1	Smoking on the airside	Fine as per Section 1.24 of the AVCH
<b>9. PEDESTRIAN SAFETY</b>		
9.1	Failure to give way to a pedestrian	Loss of 6 penalty points
<b>10. TOWING OF FREIGHT DOLLIES</b>		
10.1	Towing more than the allowable number of dollies	Loss of 6 penalty points
10.2	Failure to secure load or equipment	<b>1 month ADA suspension</b> and a loss of 4 penalty points
10.3	Driving/towing oversized equipment under Aerobridge / Fixed link	Loss of 6 penalty points
<b>11. RIDING ON EQUIPMENT</b>		
11.1	Carrying a passenger when there is no seat provided	<b>1 month ADA suspension</b> and a loss of 6 penalty points
<b>12. SEAT BELTS</b>		
12.1	Driving airside without wearing a seat belt where fitted	Loss of 3 penalty points
<b>13. BICYCLES, TRICYCLES AND MOTORISED SKATEBOARDS</b>		
13.1	Riding any of the above Airside	Loss of 1 penalty point
<b>14. FAILURE TO FOLLOW DIRECTIONS</b>		
14.1	Failure to follow directions of an Authorised Person	Loss of 3 penalty points
14.2	Failure to show Authority to Drive Airside when requested by an Airport Operations Officer	Loss of 3 penalty points
14.3	Taking children or an animal airside	Loss of 2 penalty points
14.4	Failure to stop after an accident	<b>1 month ADA suspension</b>
14.5	Failure to comply with ATC instructions	<b>1 month ADA suspension</b> and a loss of 6 penalty points
14.6	Unauthorised interference with Aviation safety devices deployed by BAC - Unserviceability Markers/Lights/Witches Hats	<b>1 month ADA suspension</b>
<b>15. FAILURE TO ABIDE BY AIRSIDE MARKINGS / LIGHTING SYSTEMS</b>		
15.1	Failure to stop at a Stop sign	Loss of 6 penalty points
15.2	Failure to give way at a Give Way sign	Loss of 3 penalty points
15.3	Disobeying traffic signals	Loss of 3 penalty points
15.4	Disobeying traffic direction	Loss of 3 penalty points
15.5	Failure to stop at a live Taxiway/Apron Taxilane crossing	<b>1 month ADA suspension</b> and a loss of 6 penalty points
15.6	Crossing Runway Stop Bars whilst illuminated	<b>6 month ADA suspension</b> and a loss of 10 penalty points
<b>16. EXCEEDING AUTHORITY / ATC CLEARANCE</b>		
16.1	Driving on the Perimeter Road without the appropriate Authority	Driver banned from applying for an ADA for 3 months

16.2	Driving on the Aircraft Stand without the appropriate Authority	Loss of 8 penalty points
16.3	Driving on the Apron Taxi lane without the appropriate Authority	<b>1 month ADA suspension</b> and a loss of 6 penalty points
16.4	Driving on the Taxiway without the appropriate Authority / ATC clearance	<b>2 month ADA suspension</b> and a loss of 8 penalty points
16.5	Driving on the Runway without the appropriate Authority / ATC clearance	<b>6 month ADA suspension</b> and a loss of 10 penalty points
16.6	Escorting a vehicle without the appropriate authority	Loss of 3 penalty points
16.7	Crossing a live Taxiway during low visibility procedures	<b>2 month ADA suspension</b> and a loss of 8 penalty points
<b>17. RUNWAY CROSSING / ENTRY REQUIREMENTS</b>		
17.1	Unauthorised vehicle crossing Runway	<b>1 month ADA suspension</b> and a loss of 6 penalty points
<b>18. OTHER</b>		
18.1	Operating a phone that is not hands free while driving airside	<b>1 month ADA suspension</b> and a loss of 4 penalty points
18.2	Operating a personal entertainment audio device whilst operating a vehicle.	<b>1 month ADA suspension</b> and a loss of 4 penalty points
18.3	Traversing the Perimeter Road in reverse direction	<b>1 month ADA suspension</b>
18.4	Operating an un-roadworthy vehicle airside	Loss of 3 penalty points
18.5	Any other activity that may constitute a hazard to aircraft operations or airside safety	To be examined on a case by case basis

# APPENDIX B

## AIRSIDE DRIVERS MAP

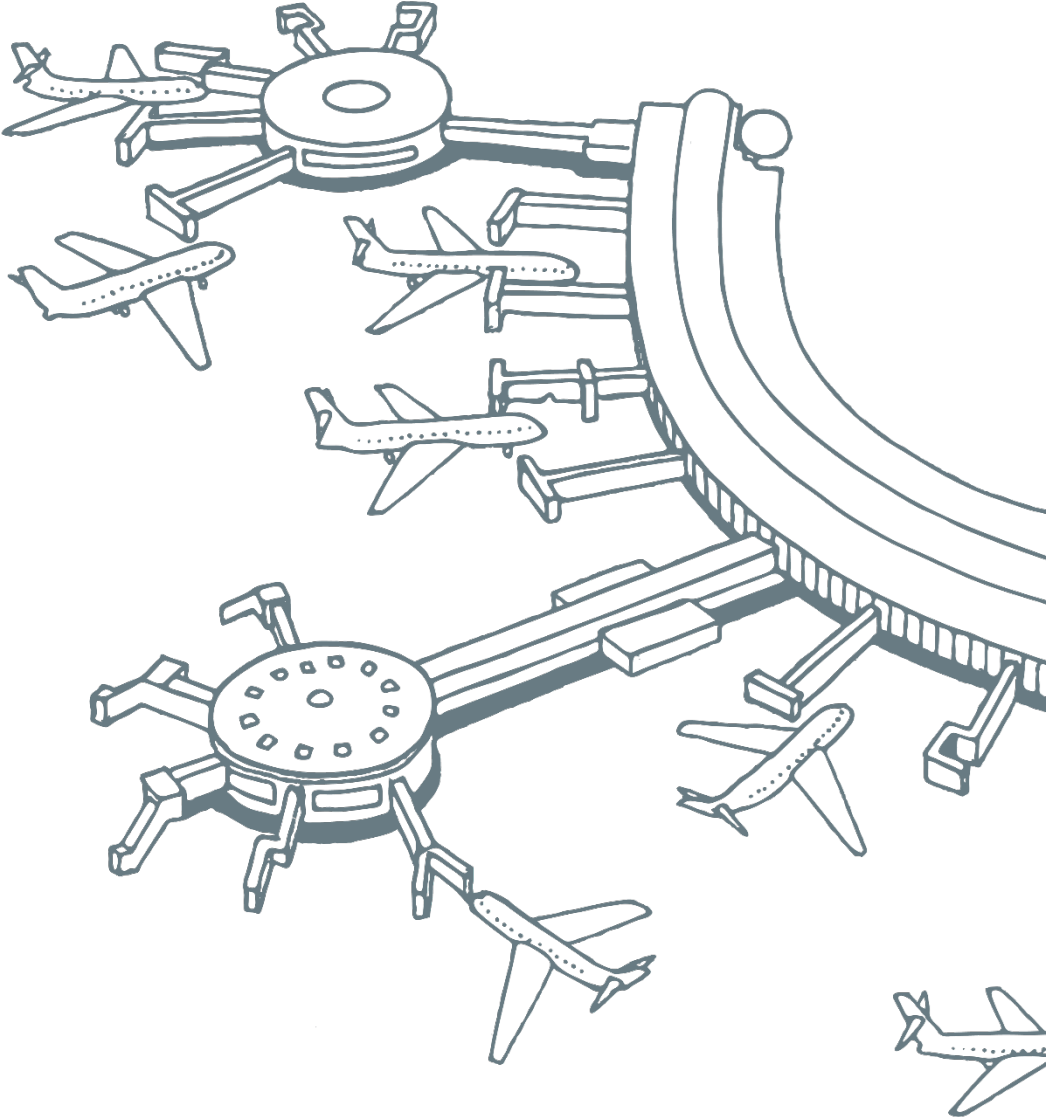

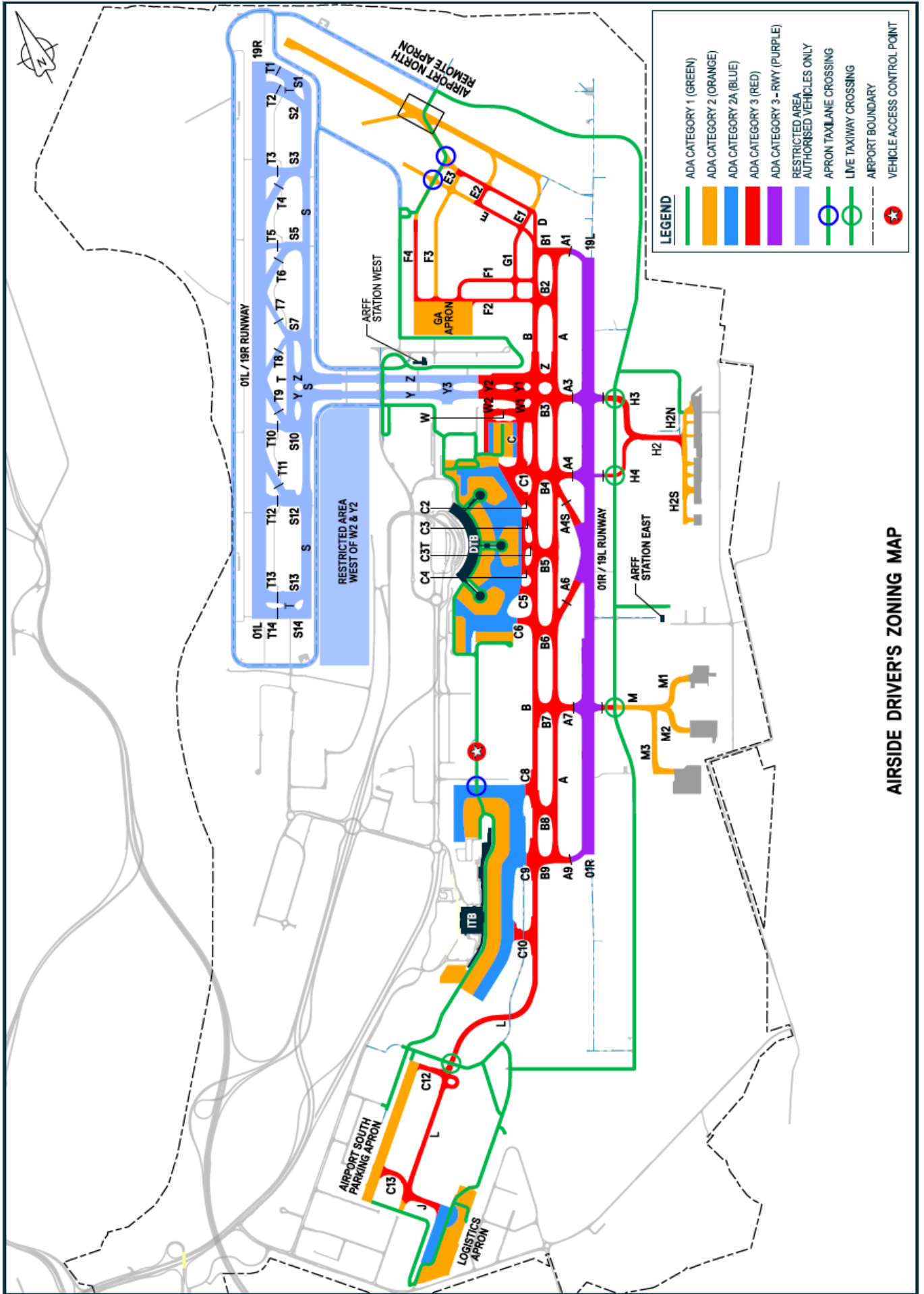

**AIRSIDE DRIVER'S ZONING MAP**

# APPENDIX C TAXIWAY AIRCRAFT DIRECTIONAL FLOW MAPS

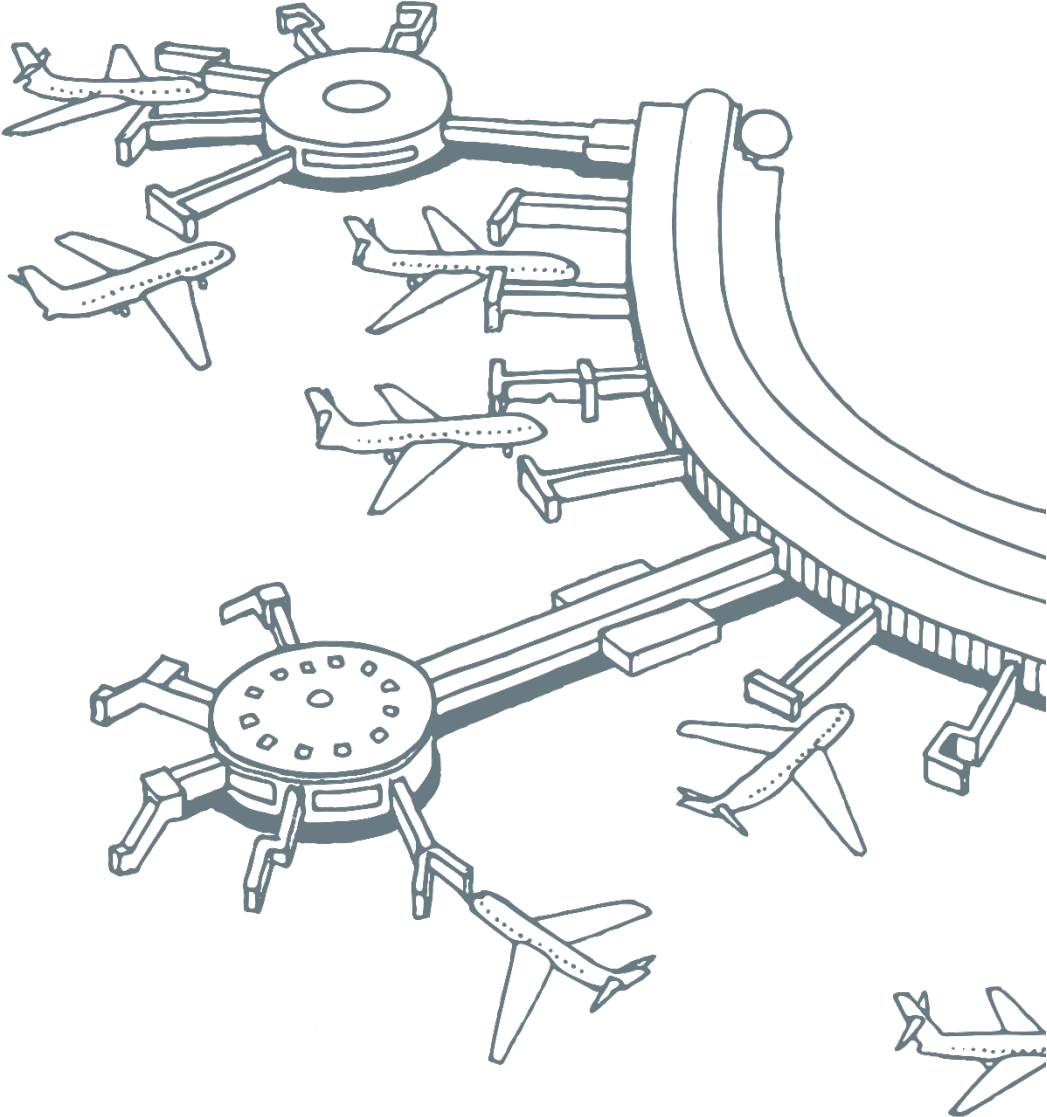



# RWY 01L/R TAXIWAY FLOW



➔ DEPARTURE 01L  
➔ ARRIVAL 01L

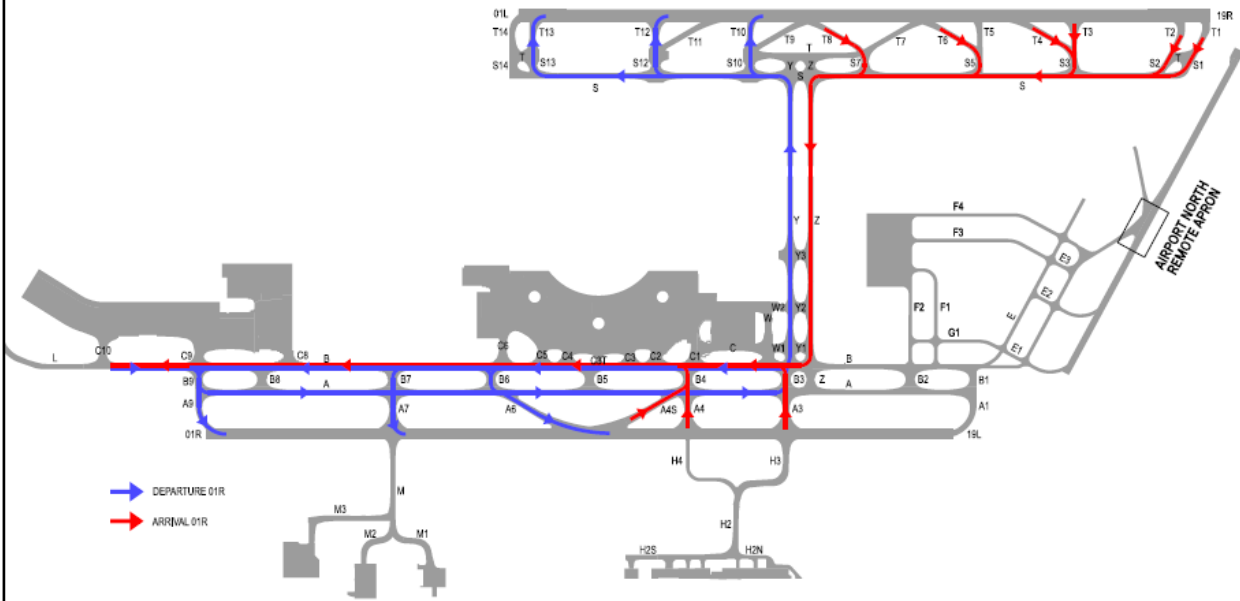

# RWY 19L/R TAXIWAY FLOW



➔ DEPARTURE 19R  
➔ ARRIVAL 019R

